

# ARTESYN LPS360-M SERIES

360 Watts (forced air)  
240 Watts (convection)



## PRODUCT DESCRIPTION

Advanced Energy's Artesyn LPS360-M series power supply features a universal 90 to 264Vac input and also could operate from 120Vdc to 300Vdc input. The power supply produces a tightly regulated main output, together with an 12Vdc fan output. The main output can deliver up to 240W continuously with convection cooling, or up to 360W continuously with 400LFM forced air cooling. The 12V and 24V output models could be adjusted over the range +15%/-0% over nominal set output voltage. The 15V and 48V output models could be adjusted over the range +10%/-5% over nominal set output voltage. The 36V output models could be adjusted over the range +0%/-15% over nominal set output voltage. Remote sense facilities are provided to compensate for a drop of up to 0.5V between the output terminals and the load.

## SPECIAL FEATURES

- Medical and ITE safeties
- Active power factor correction
- 3" x 5" footprint
- Less than 1U high
- EN61000-3-2 compliant
- Remote sense
- Power fail
- Adjustable main output
- Level B Conducted EMI – Class I or Class II inputs
- Overvoltage protection
- Overload protection
- Thermal overload protection
- 12V Fan output
- LPX200 enclosure kit available

- 5V Standby output
- Remote Inhibit
- Digital I2C interface
- Class I and II approved
- Dual AC fuses
- Suitable for BF Type applications

## SAFETY

- TUV 62368 / 60601-1
- UL 62368 / 60601-1
- CB Certificate and report
- CE Mark for LVD and EMC
- CCC Approval

## AT A GLANCE

### Total Power

240-360 Watts

### Input Voltage

90 to 264 Vac

### # of Outputs

Single



## Model Numbers

Standard	Output Voltage	Minimum Load	Maximum Load Convection Cooling	Maximum Load Forced Air 400LFM	Peak Load <sup>1</sup>
LPS363-M	12V	0A	20A	30A	39A
LPS364-M	15V	0A	16A	24A	31A
LPS365-M	24V	0A	10A	15A	19.5A
LPS366-M	36V	0A	6.25A <sup>2</sup>	11.25A <sup>2</sup>	14.62A
LPS368-M	48V	0A	5A	7.5A	9.75A

Note 1 - Peak current lasting <3 seconds.

Note 2 - LPS366-M is limited to the lower of the applicable power rating or current rating, which results in lowest power.

### Options

1. Enclosure Kit: LPX200
2. The AE Connector Kit for J3, J4, J5, J6: 70-841-029
3. The AE Digital connector kit: 73-769-005 (Including 73-841-030 and 73-769-001 per below)
4. I2C Mating Connector with cable: 73-841-030
5. USB to I2C Adapter with USB cable: 73-769-001

## Electrical Specifications

### Absolute Maximum Ratings

Stress in excess of those listed in the “Absolute Maximum Ratings” may cause permanent damage to the power supply. These are stress ratings only and functional operation of the unit is not implied at these or any other conditions above those given in the operational sections of this TRN. Exposure to any absolute maximum rated condition for extended periods may adversely affect the power supply’s reliability.

Table 1. Absolute Maximum Ratings							
Parameter	Model	Symbol	Min	Typ	Max	Unit	
Input Voltage	AC continuous operation	All Models	$V_{IN,AC}$	90	-	264	Vac
	DC continuous operation	All Models	$V_{IN,DC}$	120	-	300	Vdc
Maximum Output Power (Main + Fan) Convection continuous operation	All Models	$P_{O,maxCC}$	-	-	240	W	
Maximum Output Power (Main + Fan) Force air continuous operation – 400LFM	All Models	$P_{O,maxFA}$	-	-	360	W	
Isolation Voltage	Input to outputs	All Models	-	-	4000	Vac	
	Input to safety ground	All Models	-	-	1500	Vac	
	Main output to safety ground	All Models	-	-	1500	Vac	
Ambient Operating Temperature	All Models	$T_A$	-20	-	+70 <sup>1</sup>	°C	
Cold Start-up Temperature	All Models	$T_{ST}$	-30/-40 <sup>2</sup>	-	-	°C	
Storage Temperature	All Models	$T_{STG}$	-40	-	+85	°C	
Humidity (non-condensing)	Operating	All Models	10	-	90	%	
	Non-operating	All Models	10	-	95	%	
Altitude	Operating	All Models	-200	-	5,000	Meters	
	Non-operating	All Models	-300	-	16,000	Meters	

Note 1 - Derate each output at 2.5% per degree C from 50°C to 70°C.

Note 2 - -40°C startup if Standby output  $\leq$  1A (any valid load on main output); -30°C startup if Standby output  $>$  1A (any valid load on main output).

## Electrical Specifications

### Input Specifications

Table 2. Input Specifications						
Parameter	Condition	Symbol	Min	Typ	Max	Unit
Operating Input Voltage, AC	All	$V_{IN,AC}$	90	115/230	264	Vac
Input AC Frequency	All	$f_{IN,AC}$	47	50/60	63	Hz
Operating Input Voltage, DC	All	$V_{IN,DC}$	120	-	300	Vdc
Maximum Input Current ( $I_O = I_{O,maxFA}$ , $I_{SB} = I_{SB,maxFA}$ )	$V_{IN,AC} = 90Vac$	$I_{IN,max}$	-	-	5	A <sub>PK</sub>
No Load Input Current ( $V_O = ON$ , $I_O = 0$ , $I_{FAN} = 0$ )	$V_{IN,AC} = 90Vac$ $V_{IN,AC} = 264Vac$	$I_{IN,no-load}$	-	-	100 250	mA
No Load Input Power ( $V_O = ON$ , $I_O = 0$ , $I_{FAN} = 0$ )	$V_{IN,AC} = 115/230Vac$	$P_{IN,no-load}$	-	-	2.5	W
Harmonic Line Currents	All	THD	Per EN61000-3-2			
Power Factor	$I_O = I_{O,maxFA}$ $V_{IN,AC} = 115Vac$	PF	-	0.99	-	
Startup Surge Current (Inrush) @ 25 °C	$V_{IN,AC} = 230Vac$	$I_{IN,surge}$	-	-	50	A <sub>PK</sub>
Input Fuse	Internal, L and N 500Vdc/500Vac		-	-	8	A
Input AC Low Line Start-up Voltage	$I_O = I_{O,maxFA}$	$V_{IN,AC-start}$	84	-	89	Vac
Input AC Undervoltage Lockout Voltage	$I_O = I_{O,maxFA}$	$V_{IN,AC-stop}$	70	-	80	Vac
Input DC Low Line Start-up Voltage	$I_O = I_{O,maxFA}$	$V_{IN,DC-start}$	118	-	125	Vdc
Input DC Undervoltage Lockout Voltage	$I_O = I_{O,maxFA}$	$V_{IN,DC-stop}$	110	-	115	Vdc
PFC Switching Frequency	All	$f_{SW,PFC}$	-	72	-	KHz
Efficiency @ 25 °C	$V_{IN,AC} = 230Vac$ $I_O = I_{O,maxFA}$	$\eta$	-	93	-	%
Hold Up Time	$V_{IN,AC} = 220Vac$ $P_O = 240W$	$t_{Hold-Up}$	20	-	-	mSec
	$V_{IN,AC} = 220Vac$ $P_O = 360W$	$t_{Hold-Up}$	12	-	-	mSec
Turn On Delay	$V_{IN,AC} = 90Vac$ $P_O = P_{O,max}$	$t_{Turn-On}$	-	-	2	Sec
Leakage Current to safety ground	( $V_{IN} = 132Vac$ , $f_{IN,AC} = 50/60$ Hz)	$I_{IN,leakage}$	-	-	150	uA
	( $V_{IN} = 264Vac$ , $f_{IN,AC} = 50/60$ Hz)	$I_{IN,leakage}$	-	-	300	uA
System Stability	Phase Margin Gain Margin	330 $\mu$ F/A Capacitive Load	45 10		- -	$\emptyset$ dB

## Electrical Specifications

### Output Specifications

Table 3. Output Specifications							
Parameter		Condition	Symbol	Min	Typ	Max	Unit
Output Regulation		Inclusive of setpoint, line, load temperature change, warm-up drift and cross regulation	%V <sub>O</sub>	-2.0	-	+2.0	%
			%V <sub>SB</sub>	-5.0	-	+5.0	%
			%V <sub>FAN</sub>	-5.0	-	+5.0	%
Output Adjust Range <sup>1</sup>	LPS363-M LPS364-M LPS365-M LPS366-M LPS368-M	I <sub>O</sub> = 0	%V <sub>O</sub>	-0 -5 -0 -15 -5	- - - - -	+15 +10 +15 +0 +10	%
Output Ripple, pk-pk	LPS363-M LPS364-M LPS365-M LPS366-M LPS368-M	Measure with a 0.1μF ceramic capacitor in parallel with a 10μF tantalum capacitor	V <sub>O</sub>	-	-	120 150 240 360 480	mV <sub>PK-PK</sub>
	All Models		V <sub>SB</sub>	-	-	50	mV <sub>PK-PK</sub>
			V <sub>FAN</sub>	-	-	120	mV <sub>PK-PK</sub>
Convection Output Current, continuous	LPS363-M LPS364-M LPS365-M LPS366-M LPS368-M	Convection cooling	I <sub>O,maxCC</sub>	-	-	20 16 10 6.25 5	A
	All Models		I <sub>SB,maxCC</sub>	-	-	1	A
			I <sub>FAN,maxCC</sub>	-	-	0.5	A
Force Air Output Current, continuous	LPS363-M LPS364-M LPS365-M LPS366-M LPS368-M	400 LFM force air cooling	I <sub>O,maxFA</sub>	-	-	30 24 15 11.25 7.5	A
	All Models		I <sub>SB,maxFA</sub>	-	-	2	A
			I <sub>FAN,maxFA</sub>	-	-	1	A
Output Current, peak	LPS363-M LPS364-M LPS365-M LPS366-M LPS368-M	Maximum duration of 30 seconds with maximum duty cycle of 10%	I <sub>O,peak</sub>	-	-	39 31 19.5 14.62 9.75	A
V <sub>O</sub> Turn On Overshoot <sup>2</sup>	All Models	I <sub>O</sub> = 0, I <sub>SB</sub> = 0, I <sub>FAN</sub> = 0	V <sub>O</sub>	-	-	3	%V
V <sub>O</sub> Dynamic Response - Peak Deviation	LPS363-M	50% (50% to 100% of I <sub>O,maxFA</sub> ) load change Slew rate = 1A/μS Output capacitance = 100μF/A	±%V <sub>O</sub>	-	-	3	%
	Other Models		±%V <sub>O</sub>	-	-	4	%

Note 1 - The adjust pot shown on page 18.

Note 2 - The worst case overshoot is less than 3%V<sub>O</sub> or 150mV.

## Electrical Specifications

### Output Specifications

Table 3. Output Specifications Con't						
Parameter	Condition	Symbol	Min	Typ	Max	Unit
V <sub>O</sub> Dynamic Response - Setting Time	50% (50% to 100% of I <sub>O,maxFA</sub> ) load change Slew rate = 1A/μs Output capacitance = 100μF/A	t <sub>s</sub>	-	-	500	μSec
Maximum Convection Output Power, continuous	Main output + Fan output + Standby output	P <sub>O,maxCC</sub>	-	-	240	W
Maximum Force air Output Power, continuous	Main output + Fan output + Standby output, 400LFM	P <sub>O,maxFA</sub>	-	-	360	W
V <sub>O</sub> Capacitive Load	Start up	-	0	-	330	μF/A
V <sub>O</sub> Long Term Stability	Max change over 24 hours after thermal equilibrium (30 mins)	±%V <sub>O</sub>	-	-	1.0	%
V <sub>O</sub> Over Voltage Protection	Latch off (AC recycle to reset)	%V <sub>O</sub>	115	-	150	%
V <sub>O</sub> Over Current Protection	All	%I <sub>O</sub>	110	-	160	%
Over Temperature Protection	All		Auto Recovery			
Short Circuit Protection	All		Auto Recovery			
DCDC Switching Frequency	All	f <sub>SW,DC-DC</sub>	70	-	130	KHz
Remote Sense, + and -	Maximum compensation at each output line	V <sub>SENSE</sub>	-	-	500	mV

# Electrical Specifications

## LPS363-M Performance Curves

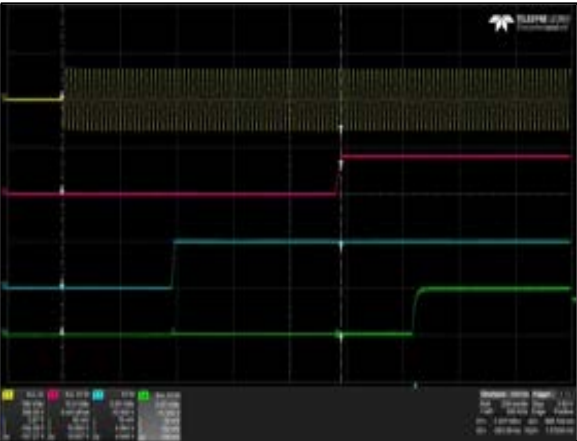

Figure 1: LPS363-M Turn-on delay  
Vin = 90Vac Load: Io = 30A, I<sub>SB</sub> = 1A  
Ch 1: V<sub>IN</sub> Ch 2: V<sub>o</sub> Ch 3: V<sub>SB</sub> Ch 4: Power Fail

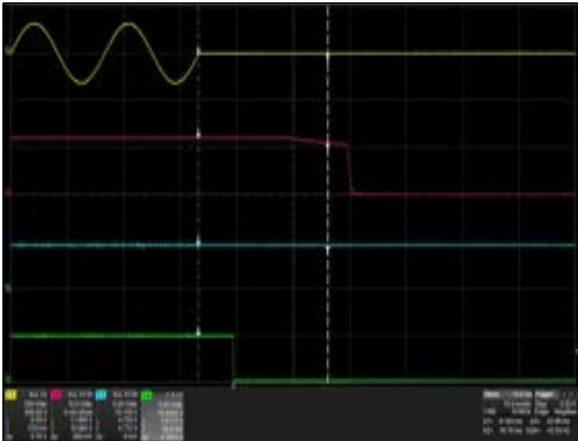

Figure 2: LPS363-M Hold-up Time (time to decay)  
Vin = 90Vac Load: Io = 30A, I<sub>SB</sub> = 1A  
Ch 1: V<sub>IN</sub> Ch 2: V<sub>o</sub> Ch 3: V<sub>SB</sub> Ch 4: Power Fail

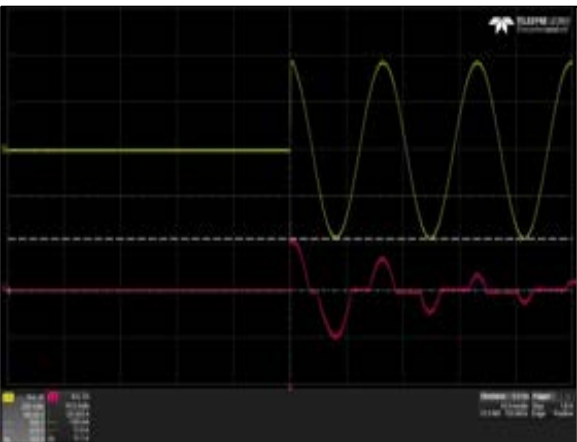

Figure 3: LPS363-M Inrush Current  
Vin = 264Vac Load: Io = 0A, Turn on at 90 deg  
Ch 1: V<sub>IN</sub> Ch 2: I<sub>IN</sub>

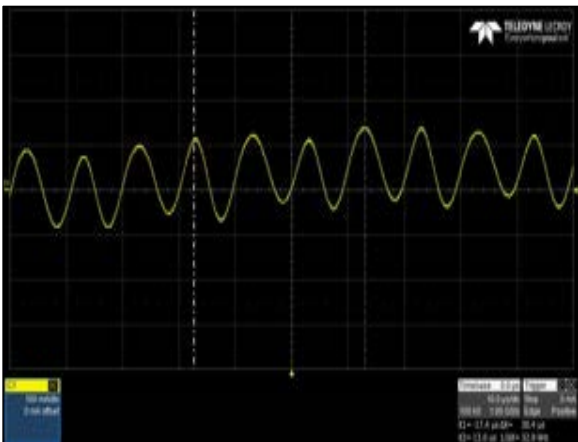

Figure 4: LPS363-M Input Current Waveform  
Vin = 220Vac Load: Io = 30A  
Ch 1: I<sub>IN</sub>

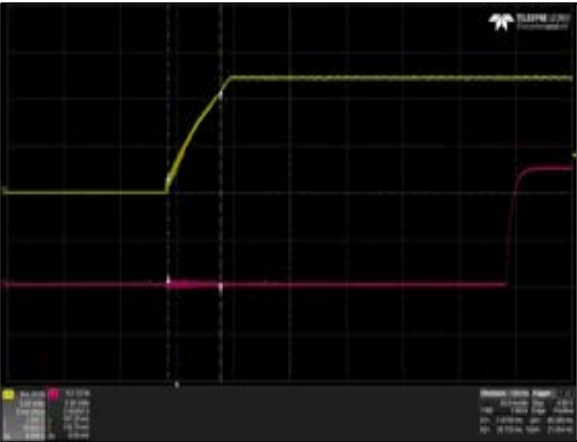

Figure 5: LPS363-M Output Voltage Startup Characteristic  
Vin = 90Vac Load: Io = 30A  
Ch 1: V<sub>o</sub> Ch 2: Power Fail Output Capacitance = 330uF/A

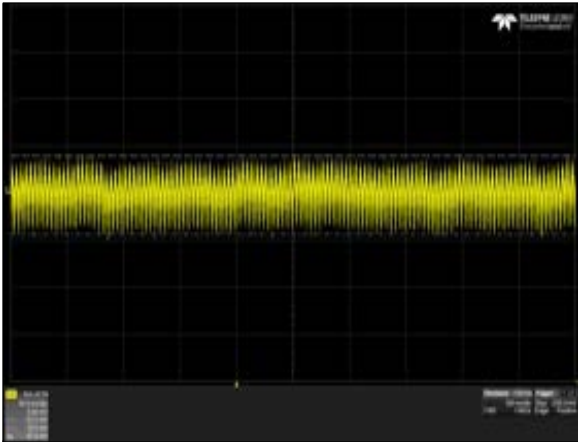

Figure 6: LPS363-M Ripple and Noise Measurement  
Vin = 115Vac Load: Io = 30A  
Ch 1: V<sub>o</sub>

# Electrical Specifications

## LPS363-M Performance Curves

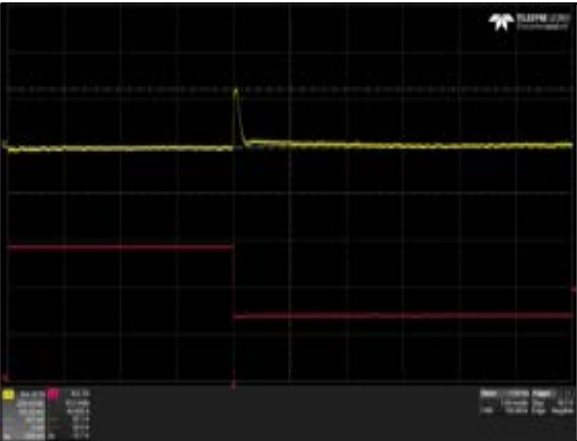

Figure 7: LPS363-M Transient Response – Vo Deviation  
 Vin = 90Vac Load: Io = 100% to 50%, 1A/us slew rate  
 Ch 1: Vo Ch 2: Io

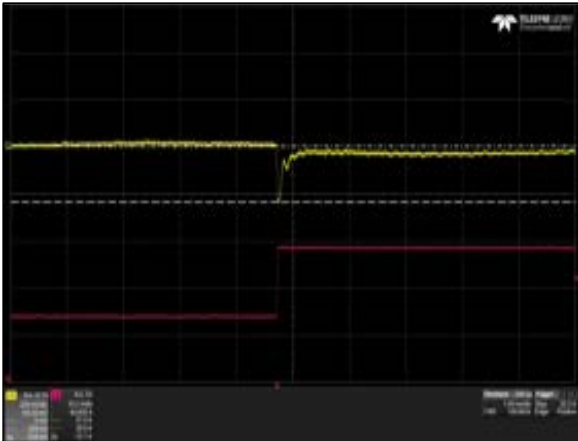

Figure 8: LPS363-M Transient Response – Vo Deviation  
 Vin = 90Vac Load: Io = 50% to 100%, 1A/us slew rate  
 Ch 1: Vo Ch 2: Io

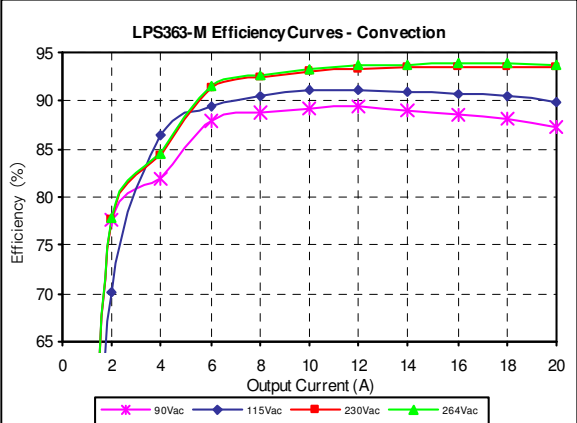

Figure 9: LPS363-M Efficiency Curves @ 25 degC  
 Convection Cooling  
 Vin = 90 to 264Vac Load: Io = 0 to 20A, I<sub>FAN</sub> = 0A

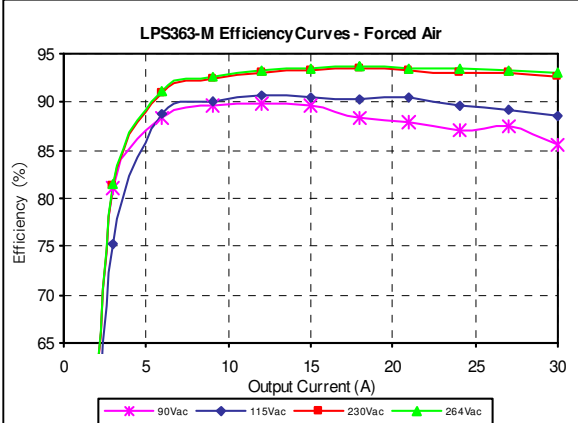

Figure 10: LPS363-M Efficiency Curves @ 25 degC  
 400 LFM Forced Air  
 Vin = 90 to 264Vac Load: Io = 0 to 30A, I<sub>FAN</sub> = 0A



# Electrical Specifications

## LPS364-M Performance Curves

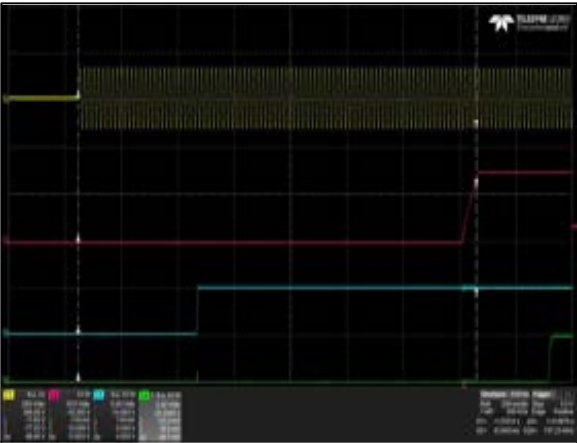

Figure 11: LPS364-M Turn-on delay  
 Vin = 90Vac Load: Io = 24A, I<sub>SB</sub> = 1A  
 Ch 1: V<sub>IN</sub> Ch 2: V<sub>O</sub> Ch 3: V<sub>SB</sub> Ch 4: Power Fail

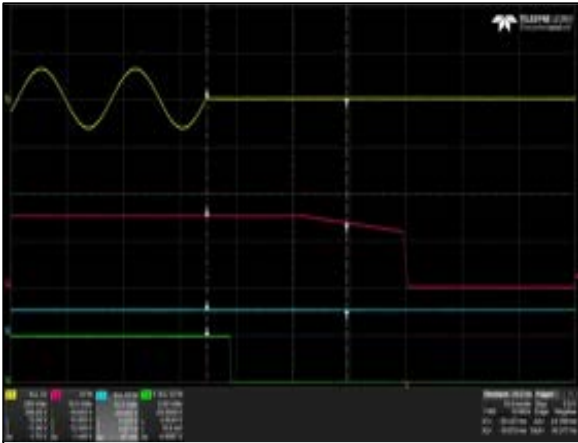

Figure 12: LPS364-M Hold-up Time (time to decay)  
 Vin = 90Vac Load: Io = 24A, I<sub>SB</sub> = 1A  
 Ch 1: V<sub>IN</sub> Ch 2: V<sub>O</sub> Ch 3: V<sub>SB</sub> Ch 4: Power Fail

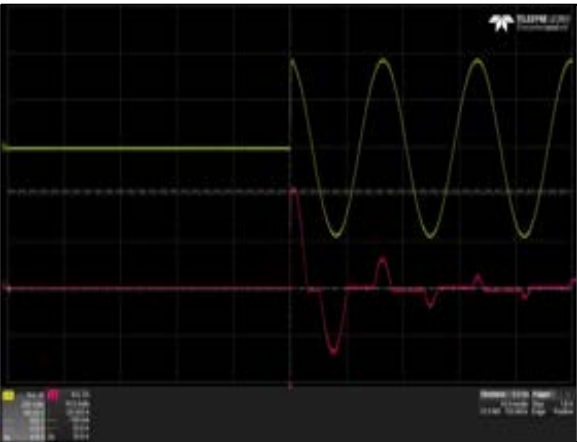

Figure 13: LPS364-M Inrush Current  
 Vin = 264Vac Load: Io = 0A, Turn on at 90 deg  
 Ch 1: V<sub>IN</sub> Ch 2: I<sub>IN</sub>

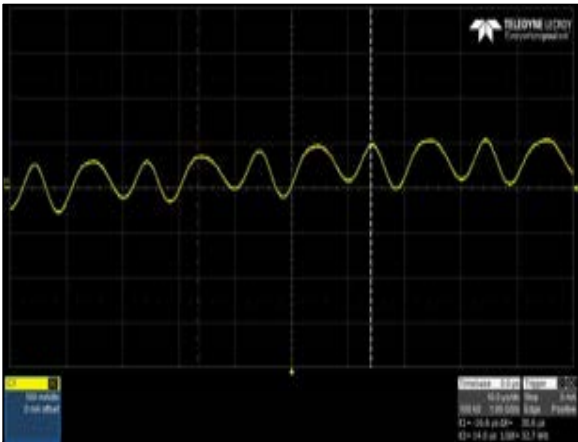

Figure 14: LPS364-M Input Current Waveform  
 Vin = 220Vac Load: Io = 24A  
 Ch 1: I<sub>IN</sub>

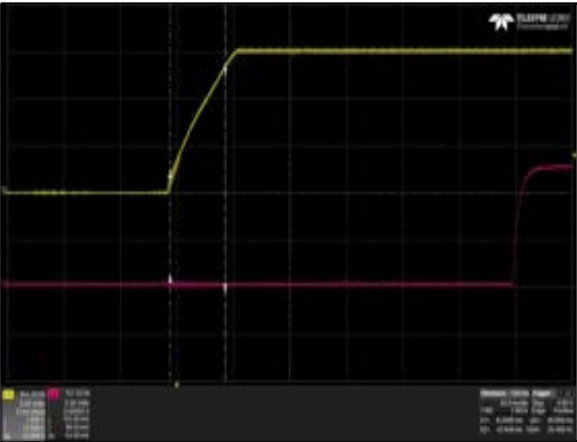

Figure 15: LPS364-M Output Voltage Startup Characteristic  
 Vin = 90Vac Load: Io = 24A  
 Ch 1: V<sub>O</sub> Ch 2: Power Fail Output Capacitance = 330uF/A

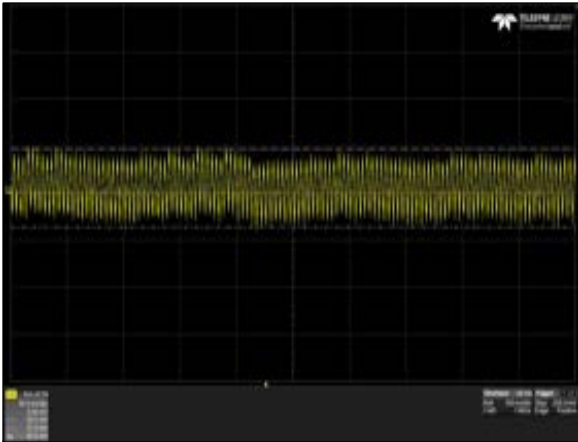

Figure 16: LPS364-M Ripple and Noise Measurement  
 Vin = 115Vac Load: Io = 24A  
 Ch 1: V<sub>O</sub>

# Electrical Specifications

## LPS364-M Performance Curves



Figure 17: LPS364-M Transient Response – Vo Deviation  
 Vin = 90Vac Load: Io = 100% to 50%, 1A/us slew rate  
 Ch 1: Vo Ch 2: Io

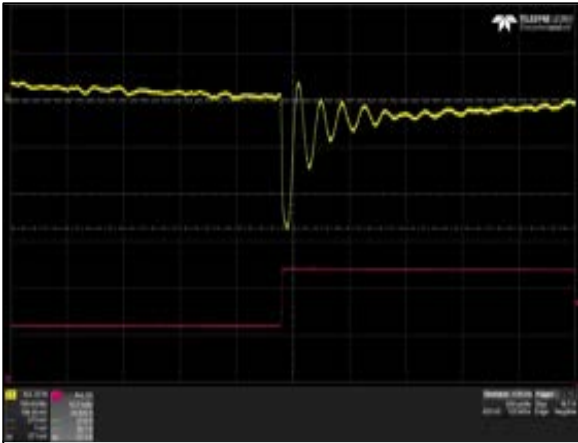

Figure 18: LPS364-M Transient Response – Vo Deviation  
 Vin = 90Vac Load: Io = 50% to 100%, 1A/us slew rate  
 Ch 1: Vo Ch 2: Io

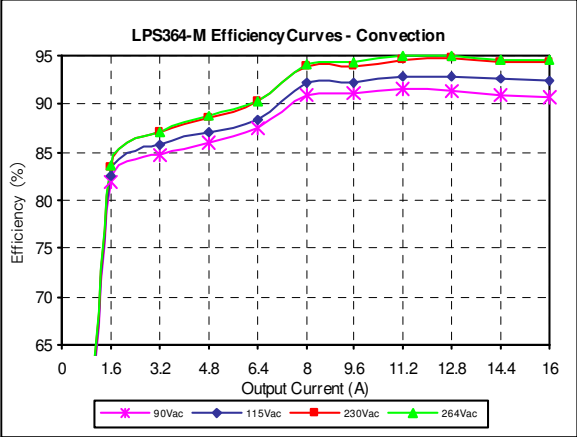

Figure 19: LPS364-M Efficiency Curves @ 25 degC  
 Convection Cooling  
 Vin = 90 to 264Vac Load: Io = 0 to 16A, I<sub>FAN</sub> = 0A

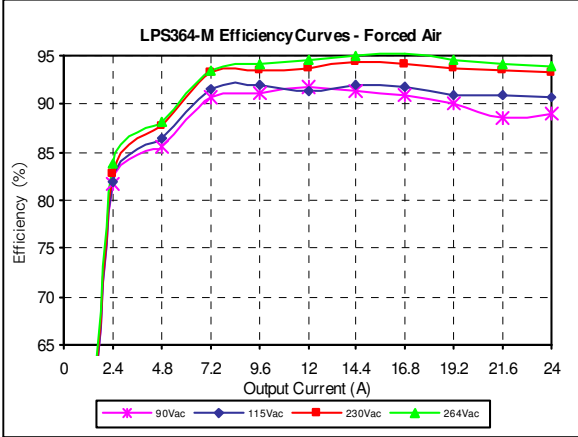

Figure 20: LPS364-M Efficiency Curves @ 25 degC  
 400 LFM Forced Air  
 Vin = 90 to 264Vac Load: Io = 0 to 24A, I<sub>FAN</sub> = 0A

# Electrical Specifications

## LPS365-M Performance Curves

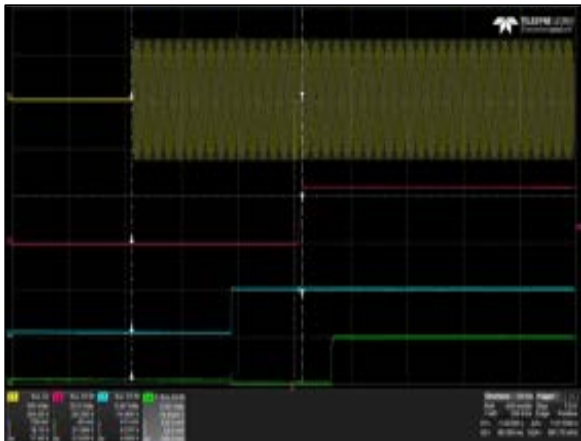

Figure 21: LPS365-M Turn-on delay  
Vin = 90Vac Load: Io = 15A, I<sub>SB</sub> = 1A  
Ch 1: V<sub>IN</sub> Ch 2: V<sub>O</sub> Ch 3: V<sub>SB</sub> Ch 4: Power Fail



Figure 22: LPS365-M Hold-up Time (time to decay)  
Vin = 90Vac Load: Io = 15A, I<sub>SB</sub> = 1A  
Ch 1: V<sub>IN</sub> Ch 2: V<sub>O</sub> Ch 3: V<sub>SB</sub> Ch 4: Power Fail



Figure 23: LPS365-M Inrush Current  
Vin = 264Vac Load: Io = 0A, Turn on at 90 deg  
Ch 1: V<sub>IN</sub> Ch 2: I<sub>IN</sub>

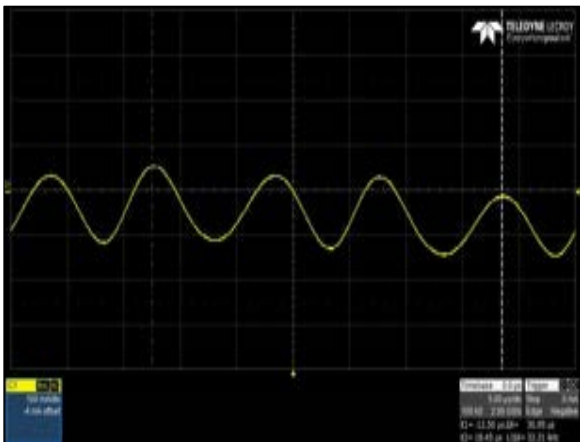

Figure 24: LPS365-M Input Current Waveform  
Vin = 220Vac Load: Io = 15A  
Ch 1: I<sub>IN</sub>

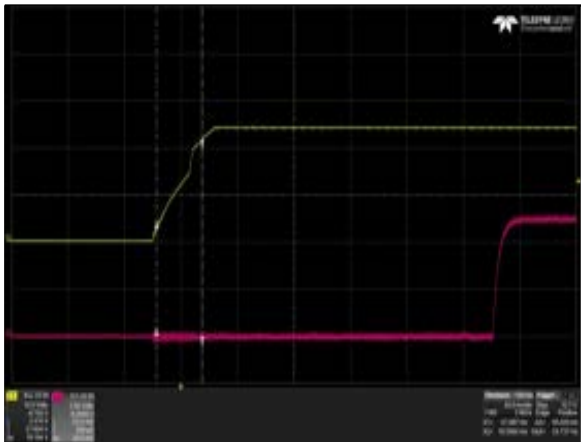

Figure 25: LPS365-M Output Voltage Startup Characteristic  
Vin = 90Vac Load: Io = 15A  
Ch 1: V<sub>O</sub> Ch 2: Power Fail Output Capacitance = 330uF/A

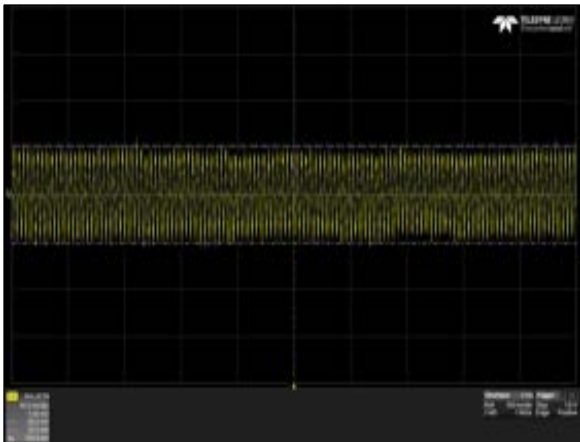

Figure 36: LPS365-M Ripple and Noise Measurement  
Vin = 115Vac Load: Io = 15A  
Ch 1: V<sub>O</sub>

# Electrical Specifications

## LPS365-M Performance Curves



Figure 27: LPS365-M Transient Response – Vo Deviation  
 Vin = 90Vac Load: Io = 100% to 50%, 1A/us slew rate  
 Ch 1: Vo Ch 2: Io



Figure 28: LPS365-M Transient Response – Vo Deviation  
 Vin = 90Vac Load: Io = 50% to 100%, 1A/us slew rate  
 Ch 1: Vo Ch 2: Io

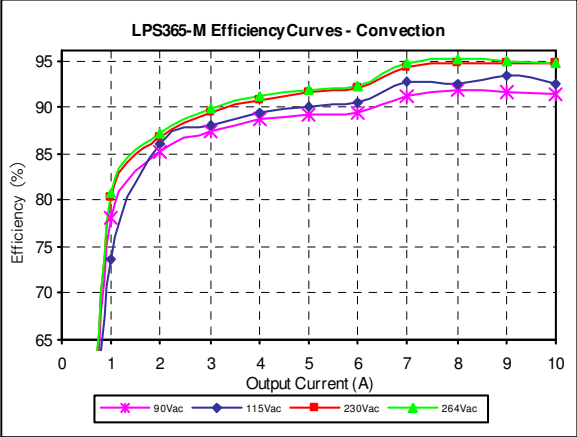

Figure 29: LPS365-M Efficiency Curves @ 25 degC  
 Convection Cooling  
 Vin = 90 to 264Vac Load: Io = 0 to 10A, I<sub>FAN</sub> = 0A

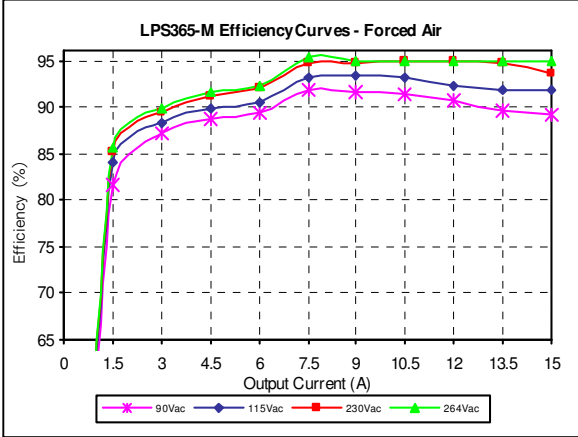

Figure 30: LPS365-M Efficiency Curves @ 25 degC  
 400 LFM Forced Air  
 Vin = 90 to 264Vac Load: Io = 0 to 15A, I<sub>FAN</sub> = 0A

# Electrical Specifications

## LPS366-M Performance Curves

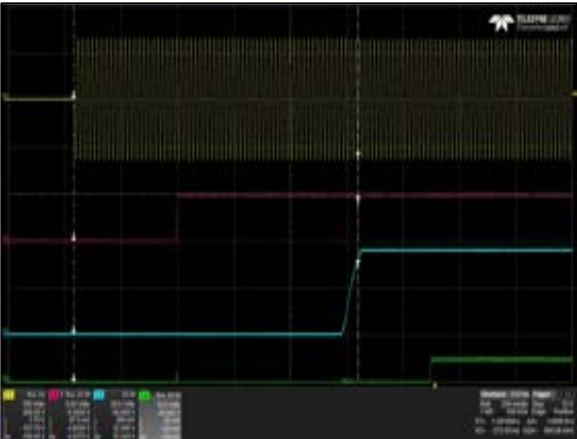

Figure 31: LPS366-M Turn-on delay  
 Vin = 90Vac Load: Io = 10A, I<sub>SB</sub> = 1A  
 Ch 1: V<sub>IN</sub> Ch 2: V<sub>O</sub> Ch 3: V<sub>SB</sub> Ch 4: Power Fail

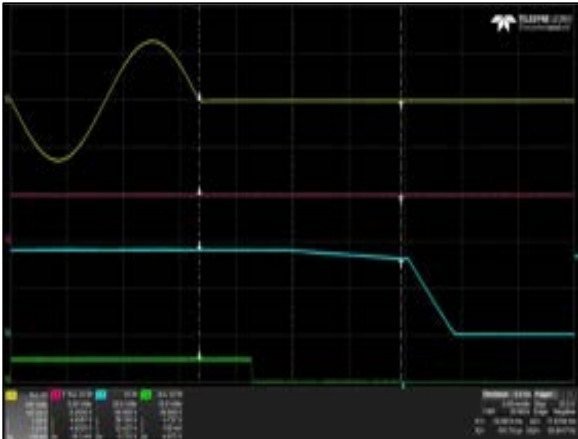

Figure 32: LPS366-M Hold-up Time (time to decay)  
 Vin = 90Vac Load: Io = 10A, I<sub>SB</sub> = 1A  
 Ch 1: V<sub>IN</sub> Ch 2: V<sub>O</sub> Ch 3: V<sub>SB</sub> Ch 4: Power Fail



Figure 33: LPS366-M Inrush Current  
 Vin = 264Vac Load: Io = 0A, Turn on at 90 deg  
 Ch 1: V<sub>IN</sub> Ch 2: I<sub>IN</sub>

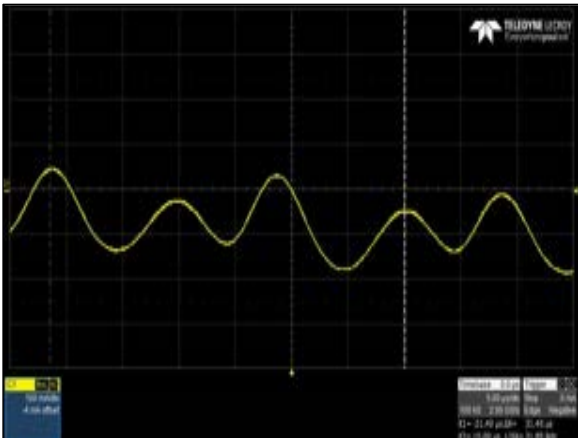

Figure 34: LPS366-M Input Current Waveform  
 Vin = 220Vac Load: Io = 10A  
 Ch 1: I<sub>IN</sub>

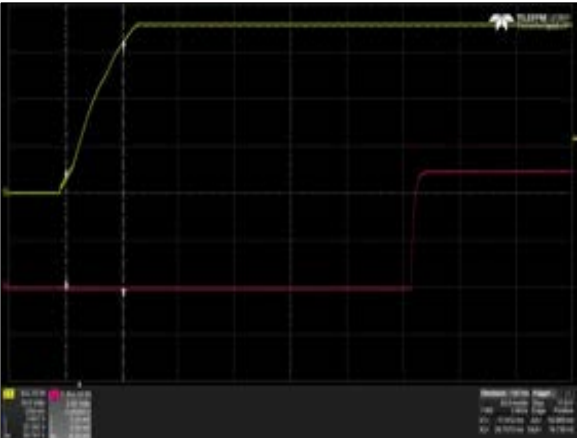

Figure 35: LPS366-M Output Voltage Startup Characteristic  
 Vin = 90Vac Load: Io = 10A  
 Ch 1: V<sub>O</sub> Ch 2: Power Fail Output Capacitance = 330uF/A

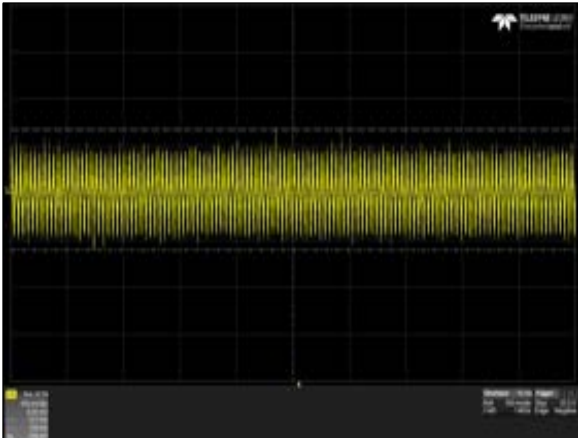

Figure 36: LPS366-M Ripple and Noise Measurement  
 Vin = 115Vac Load: Io = 10A  
 Ch 1: V<sub>O</sub>

# Electrical Specifications

## LPS366-M Performance Curves

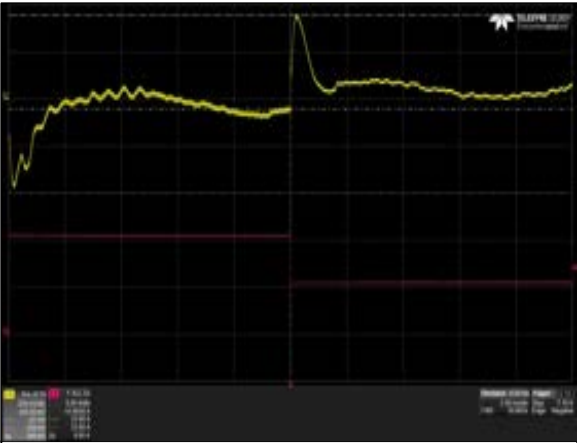

Figure 37: LPS366-M Transient Response – Vo Deviation  
 Vin = 90Vac Load: Io = 100% to 50%, 1A/us slew rate  
 Ch 1: Vo Ch 2: Io

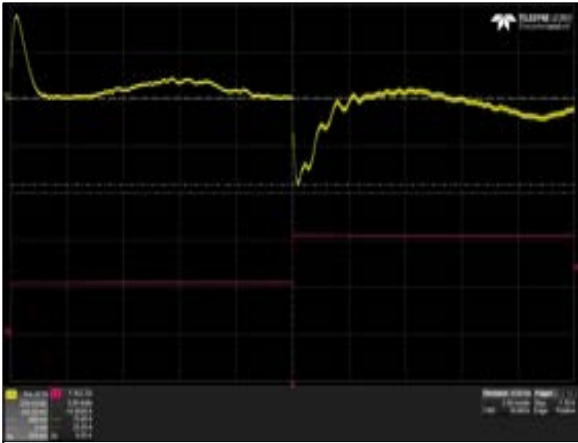

Figure 38: LPS366-M Transient Response – Vo Deviation  
 Vin = 90Vac Load: Io = 50% to 100%, 1A/us slew rate  
 Ch 1: Vo Ch 2: Io

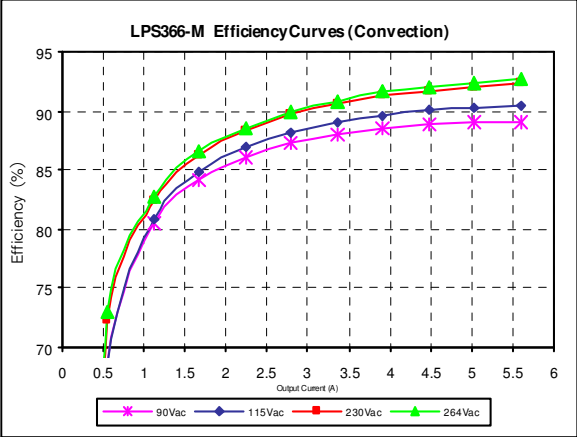

Figure 39: LPS366-M Efficiency Curves @ 25 degC  
 Convection Cooling  
 Vin = 90 to 264Vac Load: Io = 0 to 5.6A, I<sub>FAN</sub> = 0A

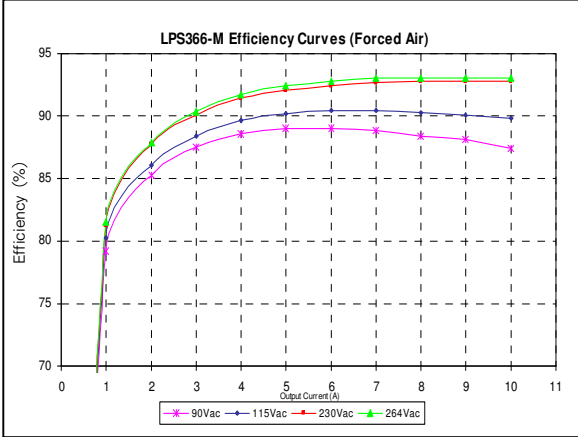

Figure 40: LPS366-M Efficiency Curves @ 25 degC  
 400 LFM Forced Air  
 Vin = 90 to 264Vac Load: Io = 0 to 10A, I<sub>FAN</sub> = 0A

# Electrical Specifications

## LPS368-M Performance Curves

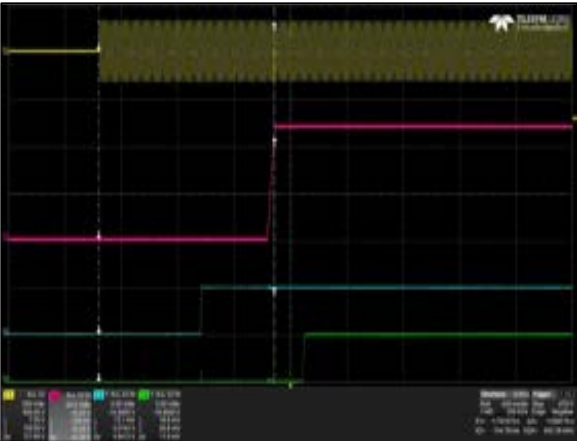

Figure 41: LPS368-M Turn-on delay  
Vin = 90Vac Load: Io = 7.5A, I<sub>SB</sub> = 1A  
Ch 1: V<sub>IN</sub> Ch 2: V<sub>o</sub> Ch 3: V<sub>SB</sub> Ch 4: Power Fail

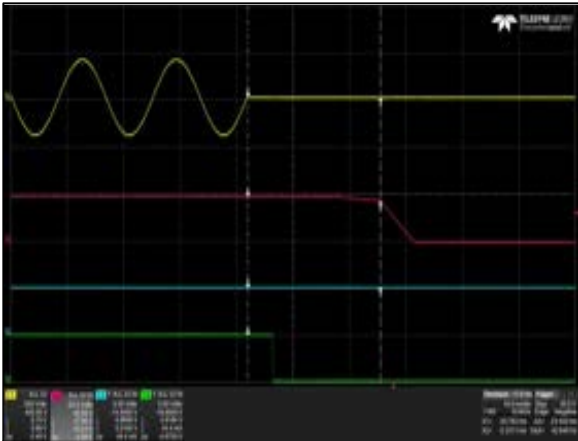

Figure 42: LPS368-M Hold-up Time (time to decay)  
Vin = 90Vac Load: Io = 7.5A, I<sub>SB</sub> = 1A  
Ch 1: V<sub>IN</sub> Ch 2: V<sub>o</sub> Ch 3: V<sub>SB</sub> Ch 4: Power Fail

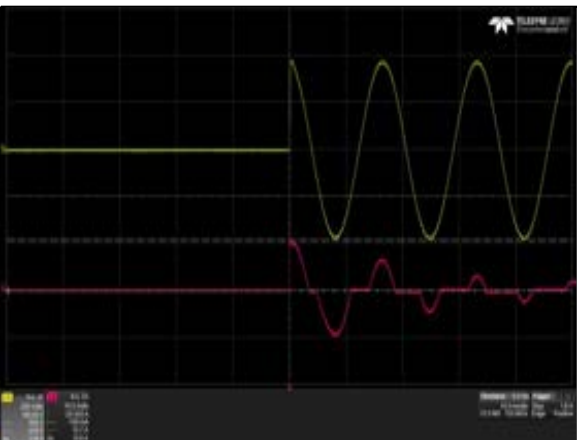

Figure 43: LPS368-M Inrush Current  
Vin = 264Vac Load: Io = 0A, Turn on at 90 deg  
Ch 1: V<sub>IN</sub> Ch 2: I<sub>IN</sub>

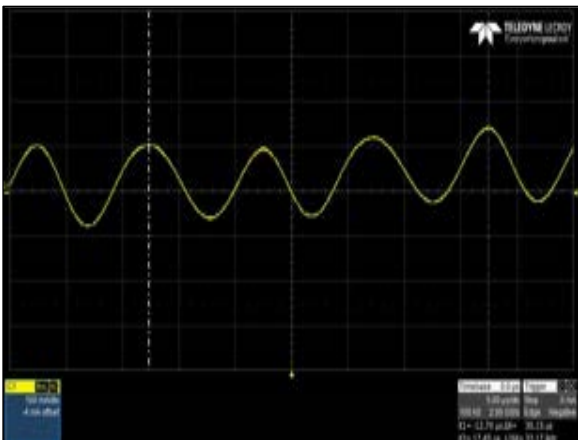

Figure 44: LPS368-M Input Current Waveform  
Vin = 220Vac Load: Io = 7.5A  
Ch 1: I<sub>IN</sub>

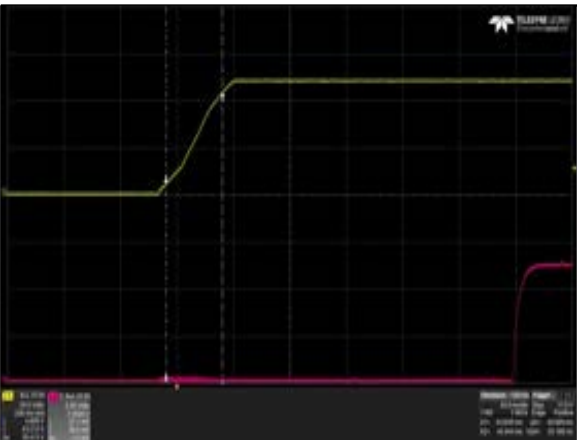

Figure 45: LPS368-M Output Voltage Startup Characteristic  
Vin = 90Vac Load: Io = 7.5A  
Ch 1: V<sub>o</sub> Ch 2: Power Fail Output Capacitance = 330uF/A

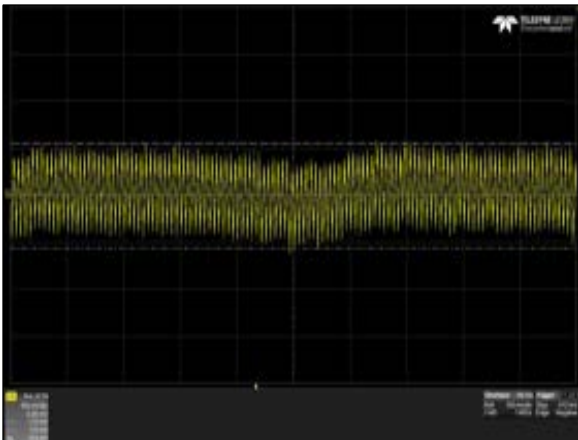

Figure 46: LPS368-M Ripple and Noise Measurement  
Vin = 115Vac Load: Io = 7.5A  
Ch 1: V<sub>o</sub>

# Electrical Specifications

## LPS368-M Performance Curves

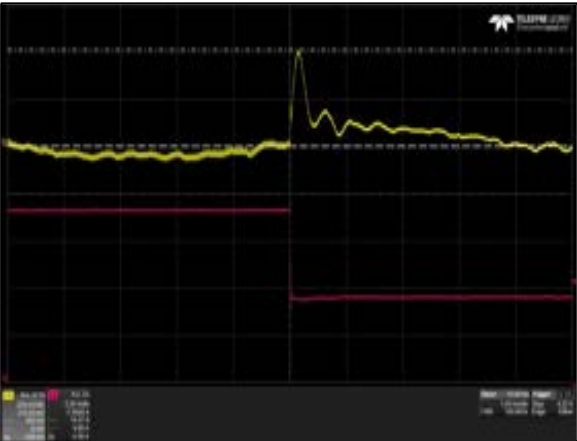

Figure 47: LPS368-M Transient Response – Vo Deviation  
 Vin = 90Vac Load: Io = 100% to 50%, 1A/us slew rate  
 Ch 1: Vo Ch 2: Io



Figure 48: LPS368-M Transient Response – Vo Deviation  
 Vin = 90Vac Load: Io = 50% to 100%, 1A/us slew rate  
 Ch 1: Vo Ch 2: Io

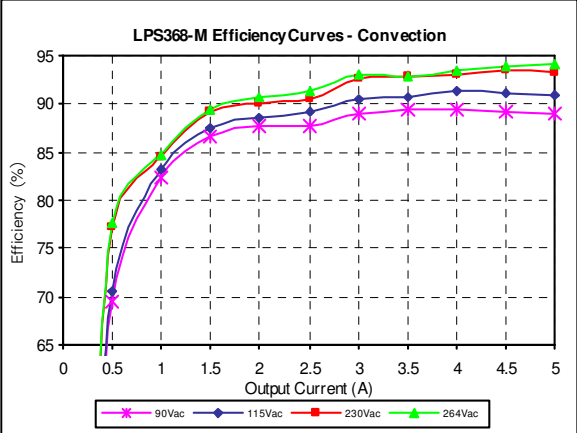

Figure 49: LPS368-M Efficiency Curves @ 25 degC  
 Convection Cooling  
 Vin = 90 to 264Vac Load: Io = 0 to 5.6A, I<sub>FAN</sub> = 0A

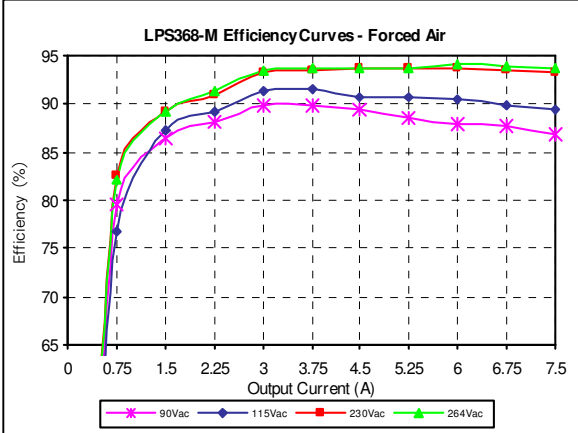

Figure 50: LPS368-M Efficiency Curves @ 25 degC  
 400 LFM Forced Air  
 Vin = 90 to 264Vac Load: Io = 0 to 7.5A, I<sub>FAN</sub> = 0A



## Electrical Specifications

### Protection Function Specifications

#### Input Fuse

Protective Fuse is provided on the “Line” and “Neutral” side of the primary line of each power supply. 500Vdc/500Vac and 8A rated.

#### Over Voltage Protection (OVP)

The LPS360-M series main output will latch off during output overvoltage with the AC line recycled to reset the latch.

Parameter	Min	Typ	Max	Unit
V <sub>O</sub> Output Overvoltage	130%	/	150%	V <sub>O</sub>

#### Over Current Protection (OCP)

The LPS360-M series power supply includes internal current limit circuitry to prevent damage in the event of overload or short circuit. The OCP mode is hiccup. Recovery is automatic when the overload is removed.

Parameter	Min	Typ	Max	Unit
V <sub>O</sub> Output Overcurrent	110	/	160	%I <sub>O,max</sub>

#### Short Circuit Protection (SCP)

The power supply will withstand a continuous short circuit with no permanent damage. The power supply will automatically restart when the short circuit is removed. A short is defines as impedance less than 50 milliohms. The SCP mode is hiccup.

#### Over Temperature Protection (OTP)

The power supply will shut down during over-temperature condition and return back to normal operation when the power supply is cooled down. The LPS360-M series power supply might experience over-temperature conditions during a persistent overload on the output. Overload conditions can be caused by external faults. OTP might also be entered due to a loss of control of the environmental conditions e.g. an increase in the converter’s ambient temperature due to a failing fan or external cooling system etc. The latch option can be a mod, as it requires firmware update.

# Mechanical Specifications

## Mechanical Outlines (Dimensioning and Mounting Locations)

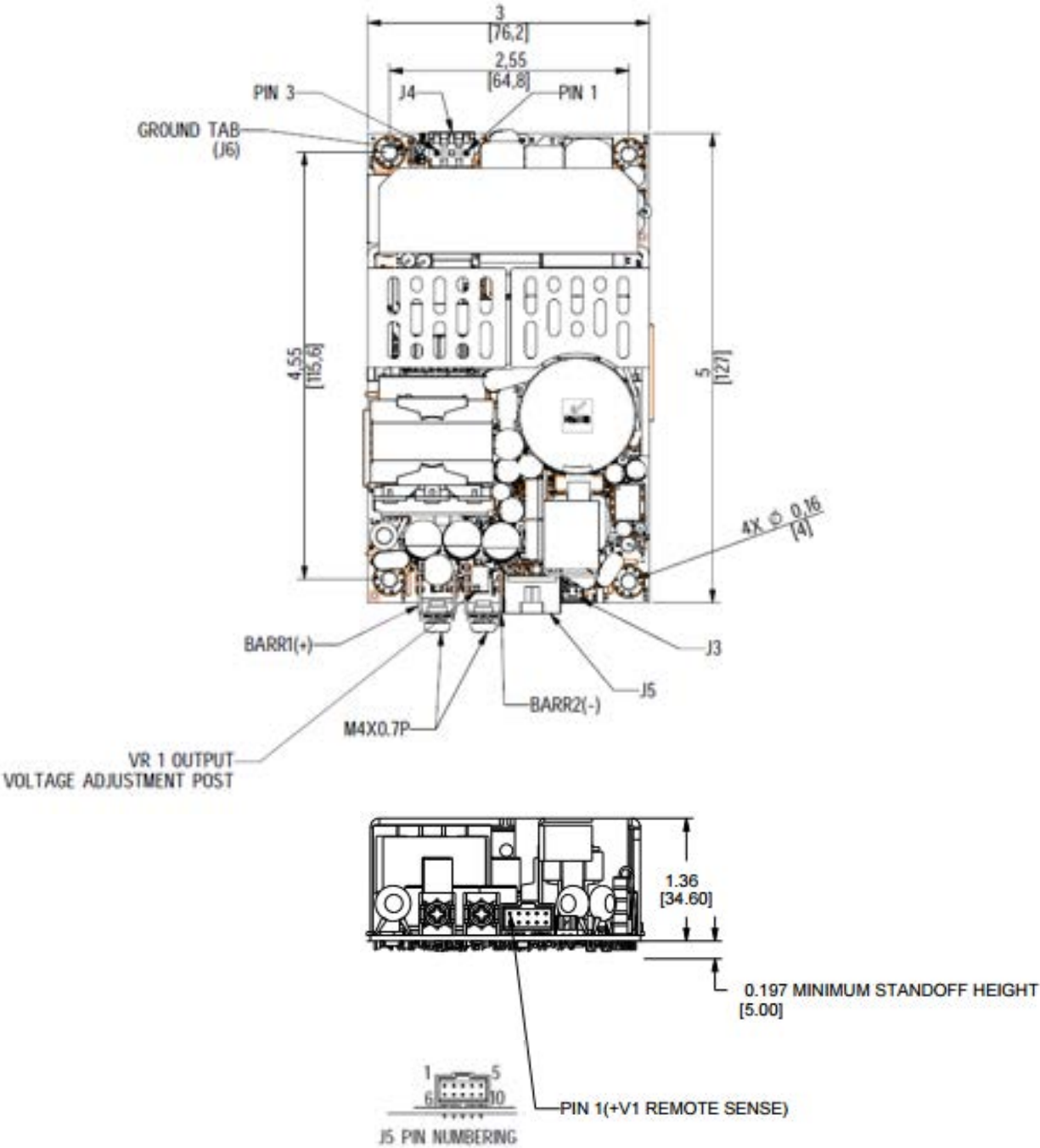

Note: All dimensions in inches (mm), tolerance is 0.02" ( $\pm 0.5$ mm)

# Mechanical Specifications

## Mechanical Outlines (Enclosure Kit)

Part number for the Enclosure Kit is LPX200.

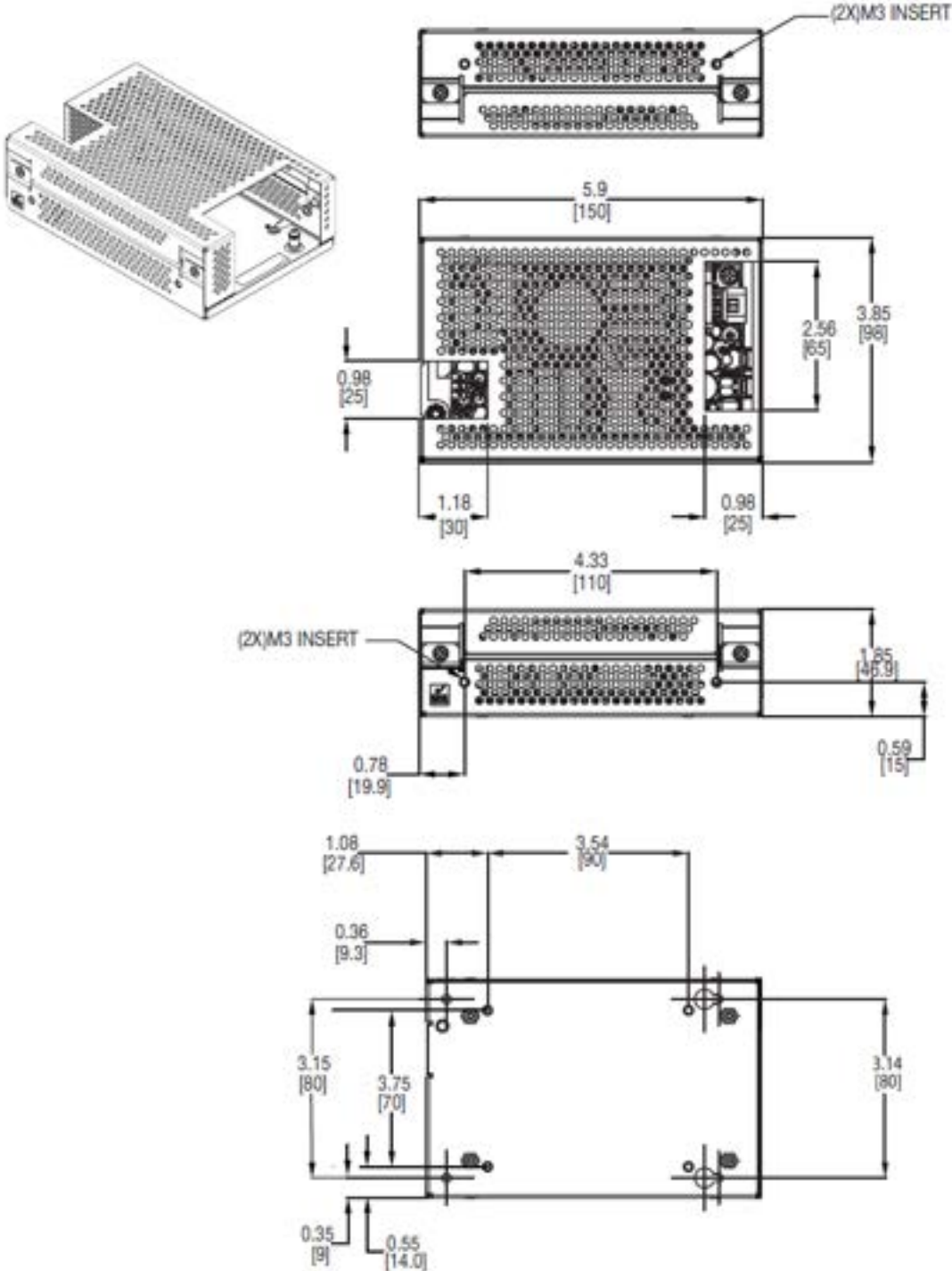

Note: All dimensions in inches (mm), tolerance is 0.02" (±0.5mm)

## Mechanical Specifications

### Connector Definitions

AC Input Connector – J4

Pin 1 - Neutral

Pin 3 - Line

Earth Ground - GND

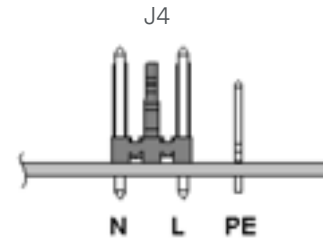

Output Connector – Barr

TB-1 – Common

TB-2 – Main output

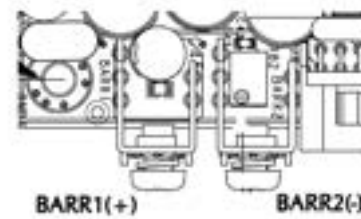

Control Signal Header – J5

Pin 1 – + Remote Sense

Pin 2 – - Remote Sense

Pin 3 – +5V Standby

Pin 4 – +5V Standby Return

Pin 5 – Power Fail

Pin 6 – Forced Air Operation

Pin 7 – Inhibit

Pin 8 – GND

Pin 9 – SDA

Pin 10 – SCL

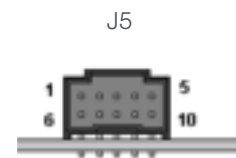

Fan Header – J3

Pin 1 – + 12V  $V_{FAN}$

Pin 2 – Fan Return<sup>1</sup>

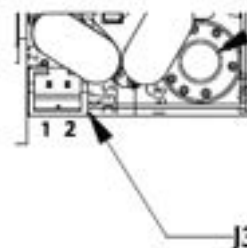

Note 1 - FAN Return is isolated from the main Output Return

# Mechanical Specifications

## Power / Signal Mating Connectors and Pin Types

Table 4. Mating Connectors for LPS360-M Series	
Reference	Mating Connector or Equivalent
AC Input (J4)	Molex 09-50-3031 (housing) Molex 08-52-0072 (pins)
AC GND (J6)	Molex 01-90020001
DC Output (Barr)	Molex 19141-0058/0063 or 19099/0048 Spade lug based on Cable Ampacity/AWG
Control Signals (J5)	Molex 90142-0010 (housing) Molex 90119-2110 (pins)
Fan Output (J3)	Molex 51065-0200 (housing) Molex 50212-8100 (pins)
AC Input (J4)	Molex 09-50-3031 (housing) Molex 08-52-0072 (pins)

Note:

1. The Artesyn Connector Kit for J3, J4, J5, J6: 70-841-029
2. The Artesyn Digital connector kit: 73-769-005 (Including 73-841-030 and 73-769-001 per below)
3. I<sup>2</sup>C Mating Connector with cable: 73-841-030
4. USB to I<sup>2</sup>C Adapter with USB cable: 73-769-001

## Potentiometer Definitions

VR1 - Vo Output Adjustment

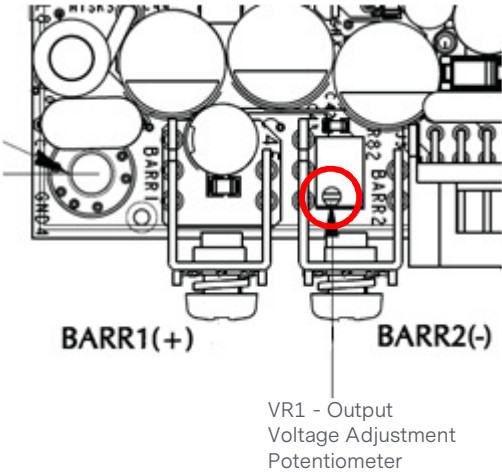

# Mechanical Specifications

## Weight

The LPS360-M series weight is 0.88lb / 400g maximum.

# Environmental Specifications

## EMC Immunity

LPS360-M series power supply is designed to meet the following EMC immunity specifications.

Table 5. Environmental Specifications											
Document	Description										
EN60601-1-2: 2001											
EN 55022	Conducted Level B and Radiated Level B (stand alone)										
IEC 61000-4-2	ESD up to 4kV contact, 8kV discharge										
IEC 61000-4-3	RFI 3V/m, criteria A										
IEC 61000-4-4	Electrical Fast Transients level 3 minimum, criteria A										
IEC 61000-4-5	Surge level 3 minimum, Criteria B.										
IEC 61000-4-6	Radio frequency common mode, Levels 3V (rms) Modulated AM 80%, 1 kHz, 150 ohm source impedance, criteria A										
IEC 61000-4-8	Power Frequency Magnetic Immunity, 1 A/m										
IEC 61000-4-11	AC Input transients  <table border="0" style="width: 100%;"> <tr> <td style="text-align: center;"><u>Condition</u></td> <td style="text-align: center;"><u>Criteria</u></td> </tr> <tr> <td>&gt; 95% dip, 0.5 period</td> <td>A</td> </tr> <tr> <td>60% dip, 5.0 periods</td> <td>B (A when Vin &gt;160 VAC)</td> </tr> <tr> <td>30% dip, 25 periods</td> <td>A</td> </tr> <tr> <td>&gt; 95% dip, 5 Sec</td> <td>B</td> </tr> </table>	<u>Condition</u>	<u>Criteria</u>	> 95% dip, 0.5 period	A	60% dip, 5.0 periods	B (A when Vin >160 VAC)	30% dip, 25 periods	A	> 95% dip, 5 Sec	B
<u>Condition</u>	<u>Criteria</u>										
> 95% dip, 0.5 period	A										
60% dip, 5.0 periods	B (A when Vin >160 VAC)										
30% dip, 25 periods	A										
> 95% dip, 5 Sec	B										
IEC 61000-3-2	Harmonic Distortion										
FCC Part 15, Subpart J, Class B	Conducted & radiated <sup>1</sup> emissions										
CISPR32 (EN55032), Class B	Conducted & radiated <sup>1</sup> emissions										

Note 1 - To be tested with system enclosure

## Environmental Specifications

### Safety Certifications

The LPS360-M series power supply is intended for inclusion in other equipment and the installer must ensure that it is in compliance with all the requirements of the end application. This product is only for inclusion by professional installers within other equipment and must not be operated as a stand alone product.

Table 6. Safety Certifications for LPS360-M Series Power Supply System		
Document	File #	Description
ES60601-1	E182560-V4-S14	Safety of Technology Equipment
UL-62368-1 (2 <sup>nd</sup> Edition)	E186249-A276-UL-X9	US Requirements
CSA -C22.2 No. 601601-1(2008)	E182560-A117-UL-X1	Medical Equipment.
EN60601-1/A1:2013	211-500076-100	European Community Safety investigated and marketed by TUV or VDE
TUV-SUD CB Cert	SG-MD-00527M1	
CE Mark	17131	LVD&EMC
CCC	C-00401-Z1603QD-00987	China Approval
IEC62368-1:2014/EN 62368-1:2014+A11:2017	E186249-A6003-CB-1	European Requirement

LPS360-M series power supply maintains basic insulation (1xMOPP) between secondary and earth and with the enclosure floating, protection Class II safety clearance requirement will still be met.



## Environmental Specifications

### EMI Emissions

The LPS360-M series power supply has been designed to comply with the Class B limits of EMI requirements of EN55032 (FCC Part 15) and CISPR 22 (EN55032) for emissions and relevant sections of EN61000 (IEC 61000) for immunity.

### Conducted Emissions

The power supply is tested under worst case conditions or AC input voltage, frequency and load conditions. The power supply will meet the following requirements with 6 dB margin across the frequency range; when tested on a wooden bench. This will be met with the output common floating or connected to ground. Additionally for single models the positive output connected to ground (operated as a negative output).

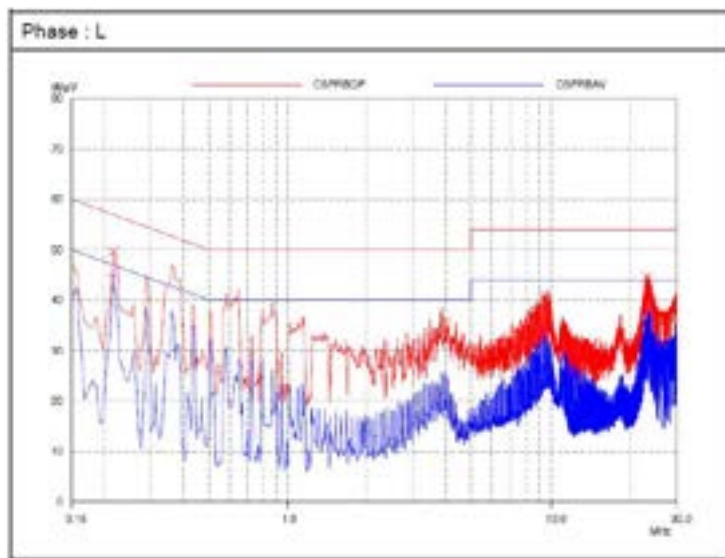

The LPS360-M series power supply have internal EMI filters to ensure the convertor's conducted EMI levels comply with EN55032 (FCC Part 15) Class B and EN55032 (CISPR 22) Class B limits. The EMI measurements are performed with resistive loads under forced air convection at maximum rated loading.

Sample of EN55032 Conducted EMI Measurement

Note: Red Line refers to Advanced Energy Quasi Peak margin, which is 6dB below the CISPR international limit. Blue Line refers to Advanced Energy Average margin, which is 6dB below the CISPR international limit.

Conducted EMI emissions specifications of the LPS360-M series:

Parameter	Model	Symbol	Min	Typ	Max	Unit
FCC Part 15, class B	All	Margin	6	-	-	dB
CISPR 22 (EN55022) class B	All	Margin	6	-	-	dB

### Radiated Emissions

For appliance IEC protection Class I operation, LPS360-M series power supply meet Class A and B conducted and radiated EMI with the LPX200 metal enclosure.

For appliance IEC protection Class II operation with earth Ground Tap floating, connect the primary and secondary y-caps for improved EMI response.

## Environmental Specifications

### Operating Temperature

The LPS360-M series power supplies will start and operate within stated specifications at an ambient temperature from -20°C to 50°C under all load conditions with 400LFM of cooling air (see below derating curves for other amount of air flow and orientation). Derate output current and power by 2.5% per degree above 50°C. Maximum operating ambient temperature is 70 °C (which implies a 50% derating at max 70°C ambient).

Under convection cooling condition, the maximum output power derates linearly from 240-200 Watts. When input voltage is 100Vac, the LPS360-M series power supply will derate from 30°C. When the input voltage is 115Vac, the power supply will derate from 40°C. When the voltage is 230Vac, the power supply will derate from 50°C.

When the loading on Standby output is ≤ 1A, the LPS360-M series power supply could startup at -40°C. When the loading on Standby output is > 1A, the power supply could startup at -30°C.

### Derating Curves

Both the ambient operating temperature and the method of cooling will limit the maximum power available from the LPS360-M series power supply.

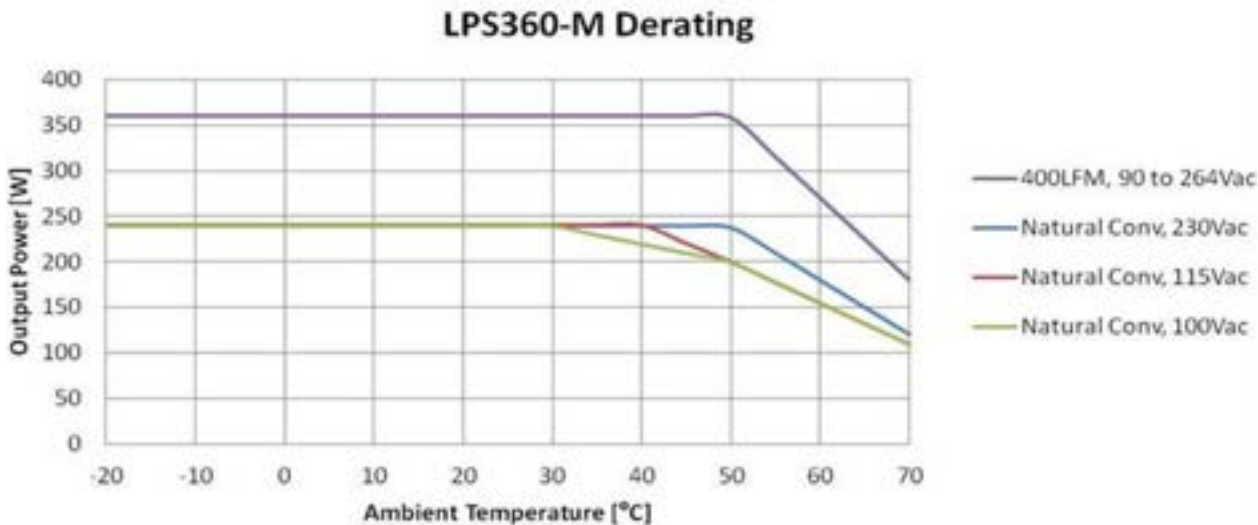

## Environmental Specifications

### Forced Air Cooling

The LPS360-M series power supply will provide 360W output with 400LFM of forced air cooling for ambient temperature up to 50°C. Above 50°C, it will require a derating of 2.5% output power per °C for operation up to 70°C.

Forced Air Cooling set up:

Pins 6 and 8 of J5 need to be connected together

Load = 100% of forced air load (360W)

Cooling Fan: Use one cooling fan with 400LFM air flow rating blowing lengthwise or sideways.

### Natural Convection Cooling

The LPS360-M series power supply will provide up to 200-240W output power under natural convection condition for ambient temperature up to 50°C. Above 50°C, it will require a derating of 2.5% output power per °C for operation up to 70°C.

Natural convection cooling defined as power supply unit mounting on flat surface with bottom of the power supply down and open top unrestricted setting (see diagram below). Other mounting orientation might produce different derating and should be evaluated.

For convection cooling, pin 6 of control connector J5 should be left unconnected, the LPM360-M series power supply will provide up to 240W load output.

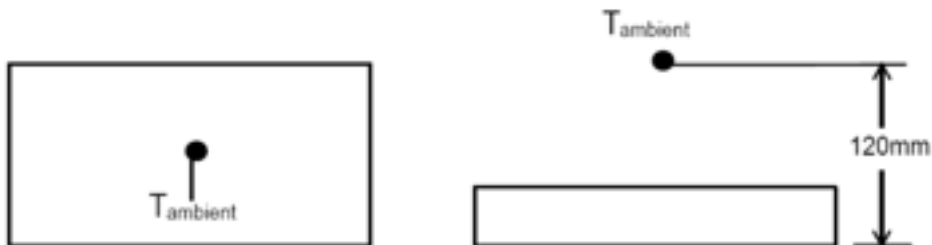

## Environmental Specifications

### Storage and Shipping Temperature / Humidity

The LPS360-M series power supply can be stored or shipped at temperatures between -40 °C to +85 °C and relative humidity from 10% to 95% non-condensing.

### Altitude

The LPS360-M series power supply will operate within specifications at altitudes up to 5,000 meters above sea level. The power supply will not be damaged when stored at altitudes of up to 16,000 meters above sea level.

### Humidity

The LPS360-M series power supply will operate within specifications when subjected to a relative humidity from 10% to 90% non-condensing. The LPS360-M series power supply can be stored in a relative humidity from 10% to 95% non-condensing.

### Vibration

The LPS360-M series power supply will pass the following vibration specifications:

#### Non-Operating Random Vibration

Acceleration	2.7	gRMS
Frequency Range	10-2000	Hz
Duration	20	mins
Direction	3 mutually perpendicular axis	
PSD Profile	<b>FREQ</b>	<b>PSD</b>
	10-190 Hz	<b>g<sup>2</sup>/Hz</b>
	190-210 Hz	0.01 g <sup>2</sup> /Hz
	210-2000 Hz	0.003 g <sup>2</sup> /Hz
	<b>SLOPE</b>	
	<b>dB/oct</b>	
	---	
	-31.213dB/oct	
	---	

#### Operating Random Vibration

Acceleration	1.0	gRMS
Frequency Range	10-500	Hz
Duration	20	mins
Direction	3 mutually perpendicular axis	
PSD Profile	<b>FREQ</b>	<b>PSD</b>
	10-500 Hz	<b>g<sup>2</sup>/Hz</b>
		0.002 g <sup>2</sup> /Hz
	<b>SLOPE</b>	
	<b>dB/oct</b>	
	---	

# Environmental Specifications

## Shock

The LPS360-M series power supply will pass the following vibration specifications

### Non-Operating Half-Sine Shock

Acceleration	30	G
Duration	18	msec
Pulse	Half-Sine	
No. of Shock	3 shock on each of 6 faces	

### Operating Half-Sine Shock

Acceleration	4	G
Duration	22	msec
Pulse	Half-Sine	
No. of Shock	3 shock on each of 6 faces	

## Power and Control Signal Descriptions

### AC Input (J4)

This connector supplies the AC Mains to the LPS360-M series power supply.

Pin 1 - Neutral

Pin 3 - Line

### Earth Ground (J6)

This tab connector is the safety ground connection and should be connected to AC input earth ground.

GND - Earth Ground (Safety Ground)

### Main Output (BARR)

These terminals provide the main output for the LPS360-M series power supply. The  $V_O$  and the Output Return terminals are the positive and negative rails, respectively of the main output of the LPS360-M series power supply. The Main Output is electrically isolated from the Earth Ground and can be operated as a positive or negative output.

BARR-1 - Main Output+

BARR-2 - Main Output Common

### Vo Output voltage adjustment

The main output of LPS363-M and LPS365-M can be adjusted by 0%~+15% from its nominal output voltage. The main output of LPS364-M and LPS368-M can be adjust by -5%~+10% from its nominal output voltage. The main output of LPS366-M can be adjusted by -15%~0% from its nominal output voltage. The adjustment potentiometer is VR1.

### 10-Pin header connector (J3)

The LPS360-M series power supply contains an isolated 12V output for powering a cooling fan or as an aux power source. This 12V Fan Supply is provided in a 2 pin header connector SK5.

Pin 1 - +12V Fan Output

Pin 2 - Fan Return

## Power and Control Signal Descriptions

### Control Signals (J5)

The LPS360-M series power supply contains a 10 pins control signal header providing control interface.

#### +Remote Sense, -Remote Sense (Remote Sensing) – (J5 – Pin 1 and Pin 2)

The main output of LPS360-M series power supply is equipped with a Remote Sensing capability that will compensate for a voltage drop of up to a 0.5V between the output terminals of the supply and the sensed voltage point (load). This feature is implemented by connecting the +V1 Remote Sense (pin 1) and the -V1 Remote Sense (pin 2) terminals to the positive and negative rails of the main output, respectively, at a location that is near to the load. Care should be taken in the routing of the sense lines as any noise sources or additional filtering components introduced into the voltage rail may affect the stability of the power supply. The LPS360-M series power supply will operate appropriately without the sense lines connected.

The power supply is protected against damage caused by inadvertent reverse connection of the Remote Sense lines.

Remote sensing has no effect on the +5V Standby output and +12V  $V_{FAN}$  output.

#### +5V Standby Output, Standby Output Return – (J5 – Pin 3 and Pin 4)

5V Standby Output rated at 2A with forced air cooling and 1A for convection cooled. If this output is shorted it will shut down the main converter.

#### Forced Air Operation – (J5 – Pin 6)

For forced air operation, connect Pin 6 to Pin 8 of J5. If these two pins are not connected, for the protection of the unit, the power is constrained to the convection rated power (200-240W).

To protect the operation of the LPS360-M, users must select the cooling method and set this pin accordingly.

For forced air cooling, this pin (pin 6) must be shorted to GND or pin 8. This sets the maximum output power to 360W. With this setting, in the event the unit does not receive the required airflow, the OTP will trigger.

For convection cooling, this pin (pin 6) must left open (default), and the maximum output power is set to 240W. Loading more than 240W under this setting might trigger OCP (over current protection).

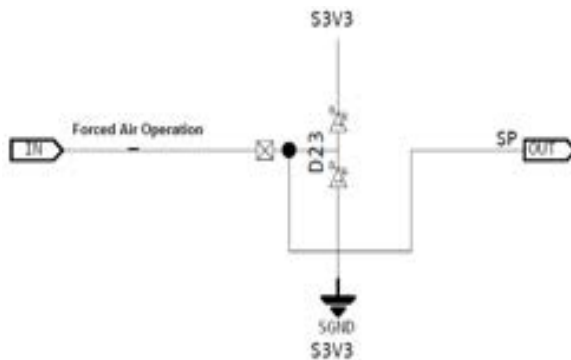

Forced Air Operation signal circuit diagram  
( Inside of LPS360-M Series Power Supply )

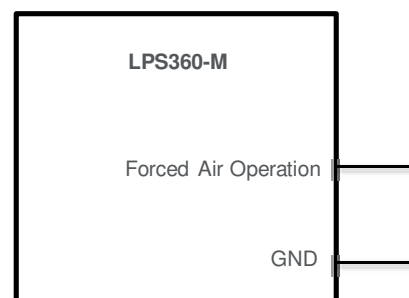

Forced Air Operation connection  
( Outside of LPS360-M Series Power Supply )

# Power and Control Signal Descriptions

### Inhibit – (J5 – Pin 7)

Remote inhibit will require Pin 7 of J5 to be grounded. Low voltage will also inhibit the power supply. Low is <0.8V and high is  $\geq 2.0V$ , source current 1mA maximum. Left the inhibit pin open will enable the power supply.

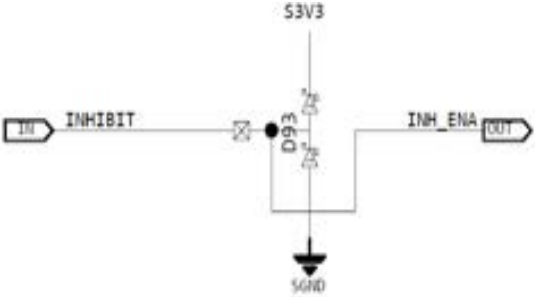

Inhibit signal circuit diagram  
( Inside of LPS360-M Series Power Supply )

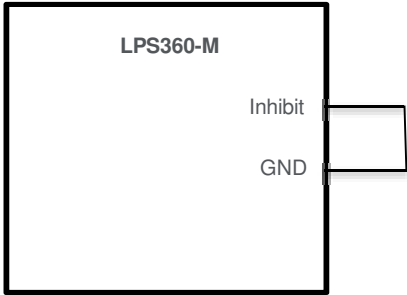

Inhibit the power supply connection  
( Outside of LPS360-M Series Power Supply )

### SDA, SCL and GND – (J5 – Pin 8, Pin 9 and Pin 10)

Please refer to “Communication Bus Descriptions” section.

### Power Fail – (J5 – Pin 5)

Power Fail is an open collector output capable of sinking 10mA maximum at 0.5Vdc. This signal is referenced to GND. Add a pull-up resistor (10K) to Standby Output or other voltage rail (12V max) for the Power Fail signal.

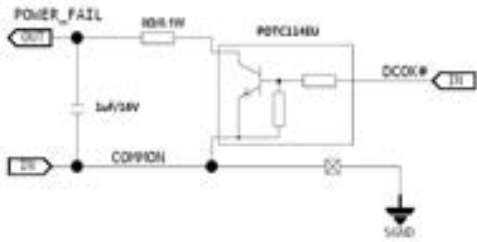

Power Fail signal circuit diagram  
( Inside of LPS360-M Series Power Supply )

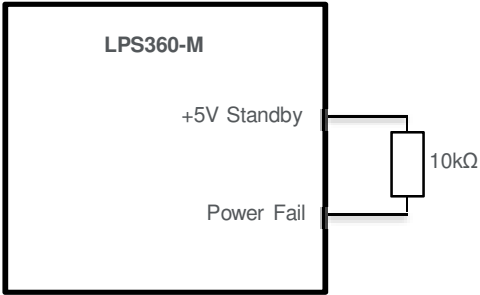

Power Fail signal circuit diagram  
( Outside of LPS360-M Series Power Supply )



# Power and Control Signal Descriptions

Power Fail signal timing diagram

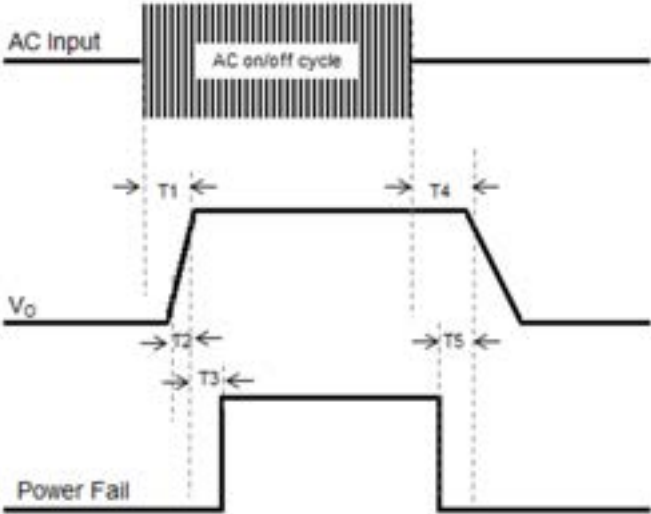

Table 7. Power Fail signal timing Specifications					
Label	Parameter	Min	Typ	Max	Unit
T1	Turn on delay - Delay from AC being applied to output voltages being within regulation with Power Fail asserted low.	-	-	2	Sec
T2	Rise up time - total time from 10%V <sub>O</sub> to 90%V <sub>O</sub>	5	-	55	mSec
T3	Delay from 90%V <sub>O</sub> to Power Fail asserted high.	100	-	500	mSec
T4	Hold up time - time all output voltages, including V <sub>SB</sub> , stay within regulation after loss of AC.	20	-	-	mSec
T5	Delay from Power Fail de-asserted to output voltages dropping out of regulation limits.	6	-	-	mSec

## Communication Bus Descriptions

### I<sup>2</sup>C Bus Signals

The LPS360-M series power supply contains a Digital I<sup>2</sup>C interface and controls functions implemented via the I<sup>2</sup>C bus. The LPS360-M series power supply I<sup>2</sup>C functionality (PMBus™) can be accessed via the control connector signals.

Note: PMBus™ functionality can be accessed only when the PSU is powered-up.  
Guaranteed communication I<sup>2</sup>C speed is 15 to 50 KHz.

### SDA, SCL (I<sup>2</sup>C Data and Clock Signals) – (J5-Pin9, J5-Pin10)

SCL: Serial clock signal; SDA: Serial data signal (bi-directional). The SCL pin and SDA pin are pulled up inside of the LPS360-M series power supply.

### I<sup>2</sup>C Bus Communication Interval

The interval between two consecutive I<sup>2</sup>C communications to the power supply should be at least 50ms to ensure proper monitoring functionality.

### Device Addressing

Slave device address is 0XB0.

# Communication Bus Descriptions

## I<sup>2</sup>C Clock Synchronization

The LPS360-M series power supply might apply clock stretching. An addressed slave power supply may hold the clock line (SCL) low after receiving (or sending) a byte, indicating that it is not yet ready to process more data. The system master that is communicating with the power supply will attempt to raise the clock to transfer the next bit, but must verify that the clock line was actually raised. If the power supply is clock stretching, the clock line will still be low (because the connections are open-drain).

### Clock Low Timeout

The PSU monitors the state of SDA and SCL lines. Whenever the SDA or SCL line gets stuck to a low level for more than 25 msec the PMBus interface will be reset and reinitialized after 2 msec. This will reset the internal state machine of the PMBus interface.

The purpose of this timeout and reset is to be able to release the bus if ever the PSU is holding one of the lines caused by signaling anomalies in the bus.

Note that the reset is only for the PMBus interface. No other PSU functionality will be affected.

### Transaction Timeout

If a transaction is not completed within 100msec a transaction timeout will occur. The timeout will cause the internal state machine of the PMBus interface to reset.

This transaction timeout is particularly useful for system with multi masters. In case a master device fails in the middle of a transaction, this timeout enables the PSU to be ready to accept another transaction from another master.

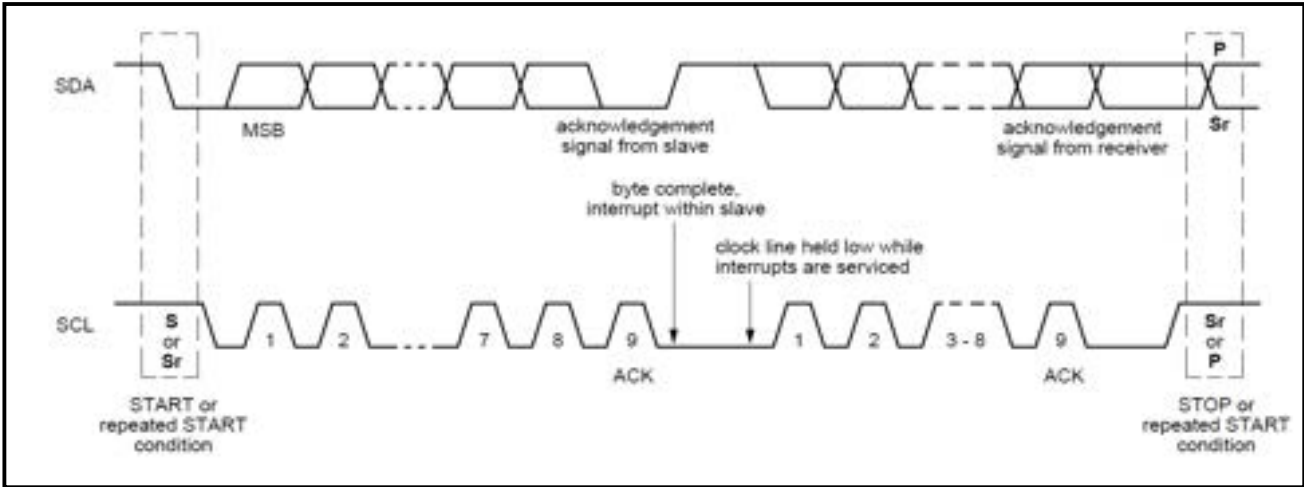

# PMBus™ Specifications

The LPS360-M series power supply is compliant with the industry standard PMBus™ protocol for monitoring and control of the power supply via the I<sup>2</sup>C interface port. The I<sup>2</sup>C Kit part number is 73-769-005.

## LPS360-M Series PMBus™ General Instructions

### Equipment Setup

The following is typical I<sup>2</sup>C communication setup:

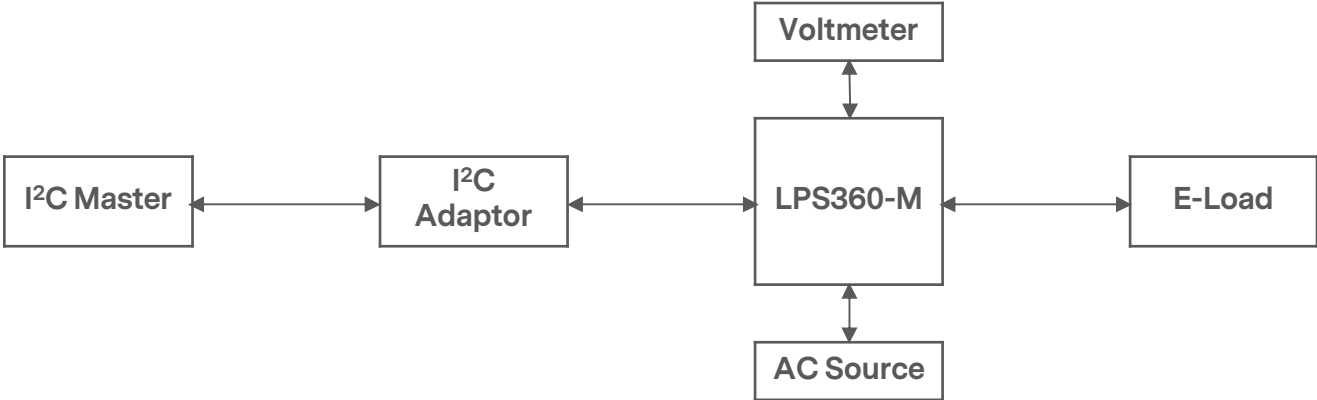

## PMBus™ Specifications

The LPS360-M is compliant with the industry standard PMBus™ protocol for monitoring and control of the power supply via the I<sup>2</sup>C interface port.

The LPS360-M Series Supported PMBus™ Command List:

Command Code	Command Name	Default Value	Access Type	Data Bytes	Data Format	Description
78h	STATUS_BYTE	00	R	1	Bd	
79h	STATUS_WORD	0000	R	2	Bd	
8Bh	READ_VOUT	-	R	2	Linear	Returns the actual, measured voltage in Volts.
8Ch	READ_IOUT	-	R	2	Linear	Returns the output current in amperes.
9Ah	MFR_MODEL	-	BR	15	ASCII	Manufacturers Model number, ASCII format
9Eh	MFR_Serial	-	BR	13	ASCII	Unit serial number, ASCII format.
E1h	FW_SEC_VERSION	-	BR	8	ASCII	

# Application Notes

## Output Ripple and Noise Measurement

The setup outlined in the diagram below has been used for output voltage ripple and noise measurements on the LPS360-M series. When measuring output ripple and noise, a scope jack in parallel with a 0.1uF ceramic chip capacitor, and a 10 uF aluminum electrolytic capacitor should be used. Oscilloscope should be set to 20 MHz bandwidth for this measurement.

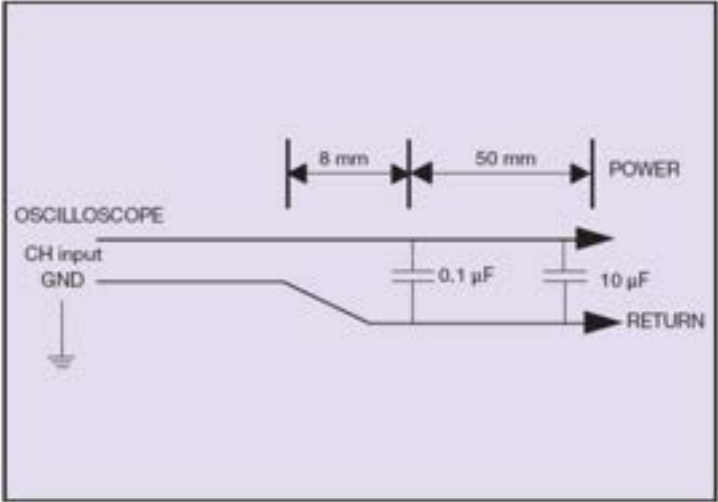

## Record of Revision and Changes

Issue	Date	Description	Originators
1.0	10.29.2015	First Issue	L. Lee
1.1	11.17.2015	Update the inrush current waveform	L. Lee
1.2	12.02.2015	Update the control signal details	L. Lee
1.3	12.11.2015	Update the efficiency typical data and Leakage current data	L. Lee
1.4	08.24.2016	Update the OCP part error	K. Wang
1.5	03.30.2017	Update the LPS366-M Data	L. Lee
1.6	07.25.2019	Update the OVP and T5 timing data	L. Lee
1.7	09.02.2019	Update the I2C Clock Frequency	K. Wang
1.8	11.21.2019	Update the EMC surge part	K. Wang
1.9	12.30.2020	Update the Isolation info/Update 62368 cert	L. Lee
2.0	03.11.2021	Add Fan regulation requirement	L.Lee



For international contact information,  
visit [advancedenergy.com](http://advancedenergy.com).

[powersales@aei.com](mailto:powersales@aei.com) (Sales Support)  
[productsupport.ep@aei.com](mailto:productsupport.ep@aei.com) (Technical Support)  
+1 888 412 7832

## ABOUT ADVANCED ENERGY

Advanced Energy (AE) has devoted more than three decades to perfecting power for its global customers. AE designs and manufactures highly engineered, precision power conversion, measurement and control solutions for mission-critical applications and processes.

Our products enable customer innovation in complex applications for a wide range of industries including semiconductor equipment, industrial, manufacturing, telecommunications, data center computing, and medical. With deep applications know-how and responsive service and support across the globe, we build collaborative partnerships to meet rapid technological developments, propel growth for our customers, and innovate the future of power.

## PRECISION | POWER | PERFORMANCE

---

Specifications are subject to change without notice. Not responsible for errors or omissions. ©2020 Advanced Energy Industries, Inc. All rights reserved. Advanced Energy®, and AE® are U.S. trademarks of Advanced Energy Industries, Inc.