



Typical Feature	
◆	Fixed Input Voltage, isolated & unregulated Output, power 1W
◆	Continuous short circuit protection
◆	Operating Temperature: -40℃ to +105℃
◆	Small SMD package, international standard pin out
◆	Isolation Voltage 1500VDC
◆	High efficiency up to 88%
◆	No load input current as low as 3mA
◆	ESD satisfy 8KV contact discharge



Application Filed

NN1-XXSXXANT is suitable for pure digital systems, low frequency analog circuits, relay-driven circuits. It is specially designed for applications where an isolated voltage is required in a distributed power supply system.

It could be widely used in the below products:

- The voltage of the input power supply is relatively stable(voltage change range:±10%Vin)*
- Isolation between input and output is required (Isolation Voltage≤1500VDC);*
- Low requirements for output voltage stability and output ripple noise;*

Typical Product List

Part No	Input Voltage	Output Voltage/Current		Max. Capacitive Load (MAX)	Ripple & Noise 20MHz (TYP/MAX)	Efficiency (MIN/TYP)
	(VDC)	Voltage	Current			
	Range	(VDC)	(mA) MAX / MIN			
NN1-3V3S3V3ANT	3.3 (2.97-3.63)	3.3	303/30	10000	50/100	74/76
NN1-3V3S05ANT		5	200/20	10000	50/100	80/82
NN1-3V3S09ANT		9	111/11	10000	50/100	83/85
NN1-3V3S12ANT		12	83/8	10000	100/150	85/87
NN1-3V3S15ANT		15	67/7	10000	100/150	85/87
NN1-3V3S24ANT		24	42/4	10000	100/150	83/85
NN1-05S3V3ANT	5 (4.5-5.5)	3.3	303/30	10000	50/100	78/80
NN1-05S05ANT		5	200/20	10000	50/100	83/85
NN1-05S09ANT		9	111/11	10000	50/100	84/86
NN1-05S12ANT		12	83/8	10000	100/150	85/87
NN1-05S15ANT		15	67/7	10000	100/150	85/87
NN1-05S24ANT		24	42/4	10000	100/150	86/88
NN1-12S3V3ANT	12 (10.8-13.2)	3.3	303/30	3000	50/100	80/82
NN1-12S05ANT		5	200/20	3000	50/100	84/86
NN1-12S09ANT		9	111/11	3000	50/100	84/86



NN1-12S12ANT		12	83/8	2200	50/100	84/86
NN1-12S15ANT		15	67/6	1000	50/100	84/86
*NN1-12S24ANT		24	42/4	560	50/100	84/86
NN1-15S05ANT	15 (13.5-16.5)	5	200/20	2200	50/100	83/85
NN1-24S3V3ANT	24 (21.6-26.4)	3.3	303/30.	3000	50/100	80/82
NN1-24S05ANT		5	200/20	3000	50/100	84/86
NN1-24S09ANT		9	111/11	3000	50/100	84/86
NN1-24S12ANT		12	83/8	2200	50/100	84/86
NN1-24S15ANT		15	67/6	1000	50/100	84/86
NN1-24S24ANT		24	42/4	560	50/100	84/86

Note 1: The typical output efficiency is based on that product is full loaded and burned-in after half an hour.

Note 2: The fluctuation range of full load efficiency(% ,TYP) is ±2%, full load output efficiency= total output power/module's input power.

Note 3: Ripple & Noise Tested by twisted-pair method, for details please check Ripple& Noise Test Method.

Input Specifications

Item	Operating Condition		Min.	Typ.	Max.	Unit
Input Current (Full load/ No load)	3.3Vdc Input	3.3Vdc/ 5Vdc output	-	370/ 5	380/ 10	mA
		9Vdc output	-	357/ 5	365/ 10	
		12Vdc/ 15Vdc output	-	348/ 10	357/ 20	
		24Vdc output	-	357/ 20	365/ 30	
	5Vdc Input	3.3Vdc output	-	244/5	250/ 10	
		5Vdc/ 9Vdc output	-	233/6	238/ 15	
		12Vdc/ 15Vdc output	-	225/15	230/ 25	
		24Vdc output	-	244/30	250/ 40	
	12Vdc Input	3.3Vdc output	-	96/ 6	104/9	
		5Vdc output	-	96/ 6	98/9	
		9Vdc/12Vdc output	-	89/6	91/9	
		15Vdc output	-	93/7	95/9	
		24Vdc output	-	-	-	
	15Vdc Input	5Vdc output	-	78/5	82/10	
	24Vdc Input	3.3Vdc output	-	47/3	50/8	
		5Vdc output	-	47/3	50/8	
9Vdc/12Vdc output		-	48/5	50/8		
15Vdc output		-	48/6	50/8		



		24Vdc output	-	-	-	
Reflected Ripple Current		-	-	15	-	
Overshoot Voltage		3.3V Input	-0.7	-	9	VDC
		5Vdc Input	-0.7		9	
		12Vdc Input	-0.7		18	
		15Vdc Input	-0.7		21	
		24Vdc Input	-0.7		30	
Overshoot Current		-	-	0.8	-	A
Input Filter Type	Capacitor Filter					
Hot Plug	Unavailable					

Output Specifications

Item	Operating Condition		Min.	Typ.	Max.	Unit
Output Voltage Accuracy	-		See Regulation Curve			
Line Regulation	Input voltage change ±1%	3.3Vdc/ 5Vdc output	-	-	±1.5	%
		Other Voltage output	-	-	±1.2	
Load Regulation	10%-100% load	3.3Vdc/ 5Vdc output	-	10	15	%
		Other Voltage output	-	8	10	
Temperature Drift Coefficient	Full load		-	-	±0.03	%/°C
Short Circuit Protection	-		Continuous, Self-recovery			

General Specifications

Item	Operating Condition		Min.	Typ.	Max.	Unit
Insulation Withstand Voltage	Input-output, Test 1min, leakage current≤0.5mA		1500	-	-	VDC
Insulation Resistance	Input-output, Insulation Voltage 500VDC		1000	-	-	MΩ
Isolation Capacitor	Input-output, 100KHz/0.1V		-	20	-	PF
Operating Temperature	Temperature≥105°C, see Temperature Derating Curve		-40	-	105	°C
Case Temperature Rise	Ambient Temperature 25°C		-	15	-	
Storage Temperature	-		-55	-	135	
Reflow Temperature	Peak temperature Tc≤250°C, maxi time is 60S for temperature above 217°C					
Storage Humidity	No condensing		-	-	95	%RH
Switching Frequency	Full load	3.3Vdc/5Vdc Input	-	260	-	KHz
		12Vdc/15Vdc/24Vdc Input	-	450	-	
MTBF	MIL-HDBK-217F@25°C		3000			K hours



Material Characteristics

Case Material		Black flame-retardant heat-resistant plastic (UL94 V-0)
Packing Dimension	SMD package	12.7X11.20X7.25 mm
Product Weight		1.4g(TYP.)
Cooling Method		Natural air cooling

EMC Character

EMI	CE	CISPR32/EN55032 CLASS B (See EMC recommended circuit)
	RE	CISPR32/EN55032 CLASS B (See EMC recommended circuit)
EMS	ESD	IEC/EN61000-4-2 Air ±8kV, Contact ±8kV perf. Criteria B

Product Character Curve

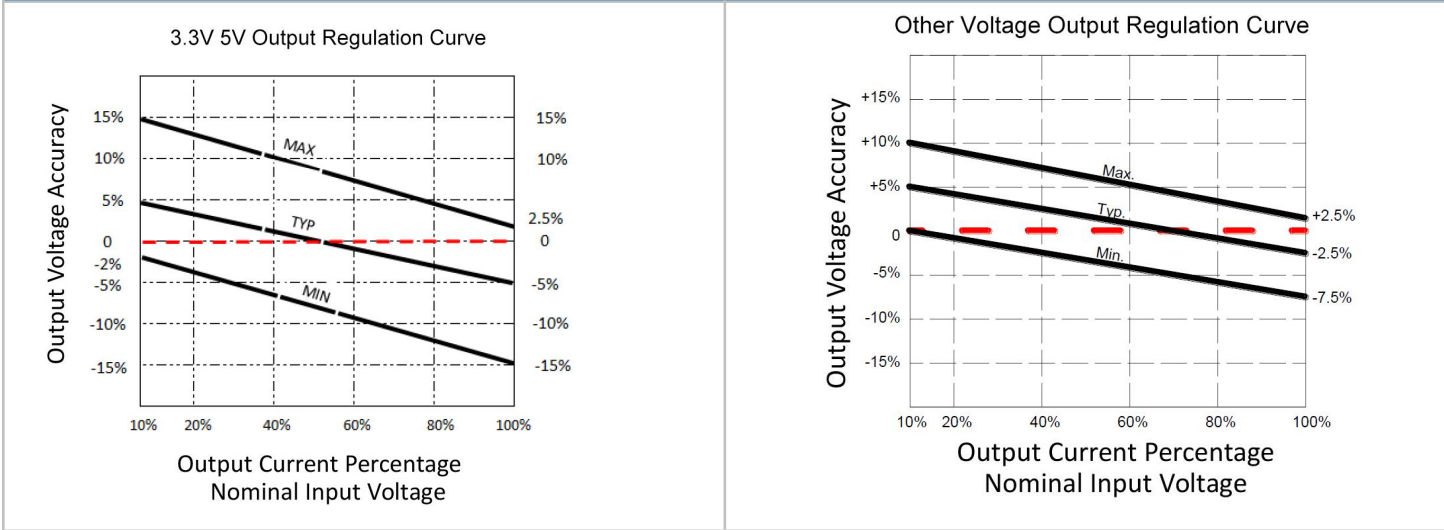

Products Characteristic Curve

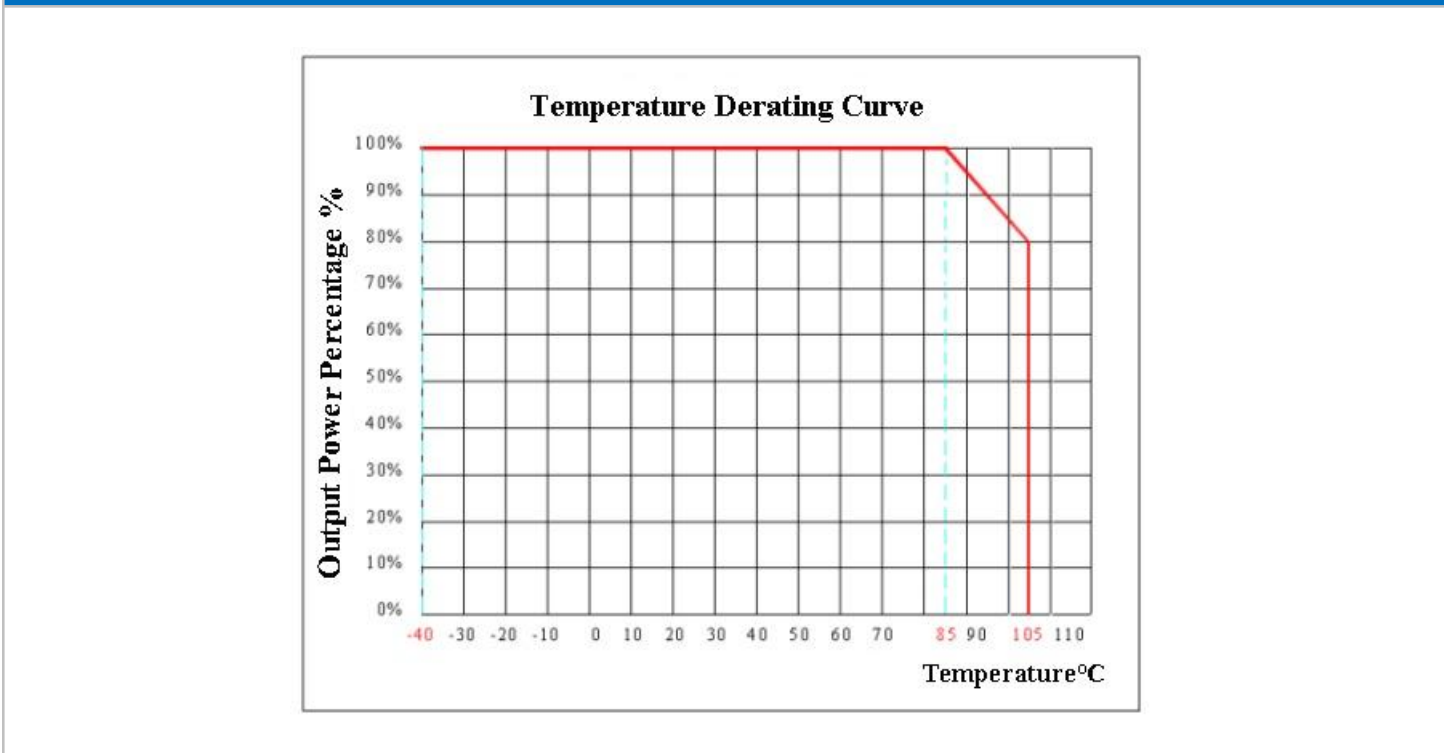



Application Circuit

1. Typical Application

In order to ensure the input/output ripple and noise decreased, capacitor filter net could be connected to input and output side, application circuit as below photo 3; choosing suitable filter capacitor is very important, start-up problems may be caused by too large capacitance.

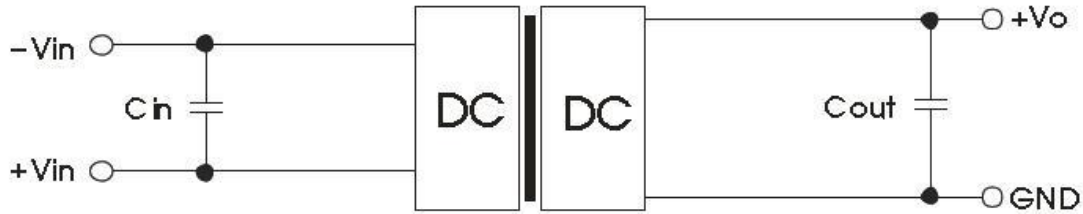

Note 1: Cin is 4.7uF/50V, Cout is 10uF/50V

2. EMC Typical Recommended Circuit

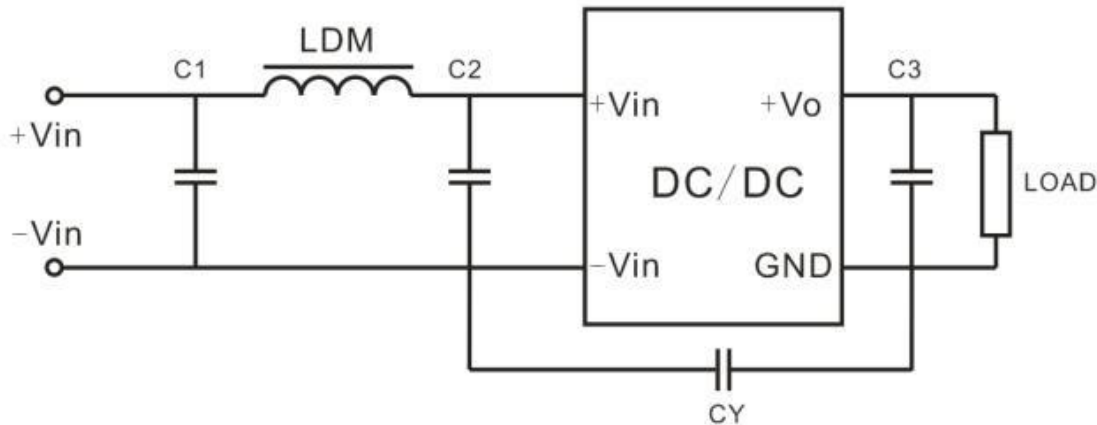

Note 2: C1,C2 are 4.7uF/50V, LDM is 6.8uH, CY is 1nF/250Vac, for C3, please refer to the Typical Circuit.

3. Ripple& Noise Test: (Twisted Pair Method 20MHZ bandwidth)

- a. 12# twisted pair to connect, Oscilloscope bandwidth set as 20MHz, 100M bandwidth probe, terminated with 0.1uF polypropylene capacitor and 4.7uF high frequency low resistance electrolytic capacitor in parallel, oscilloscope set as Sample pattern.
- b. Input terminal connect to power supply, output terminal connect to electronic load through jig plate, Use 30cm±2 cm sampling line, Power line selected from corresponding diameter wire with insulation according to the flow of output current.

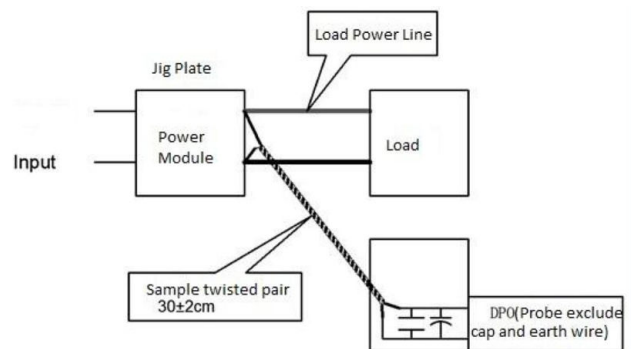

4. Output load requirement

In order to ensure the converter can work reliably with high efficiency, the minimum load should not less than 10% rated load when it is used. If the needed power is indeed small, please parallel a resistor at the output side.(The actual using power and the power of the resistor should be more than 10% rated power)



Packing Information

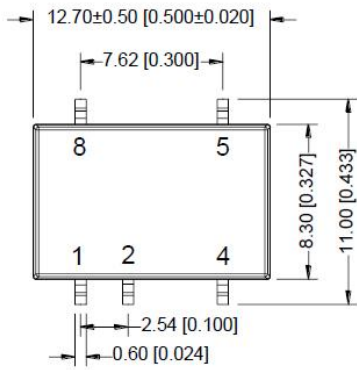

THIRD ANGLE PROJECTION

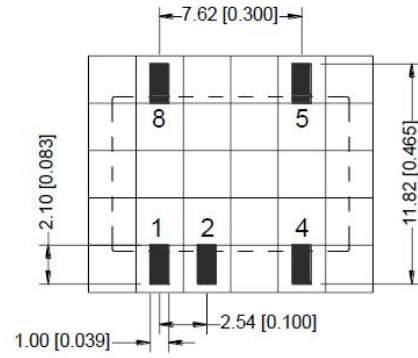
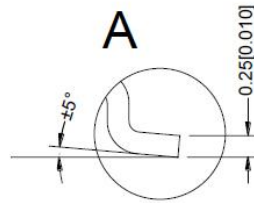

Note: Grid: 2.54*2.54mm

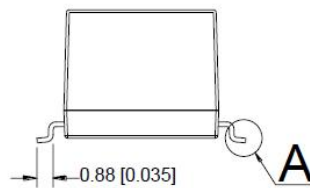
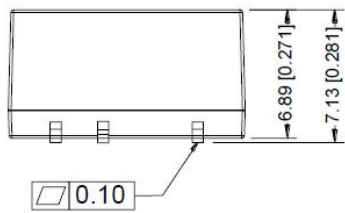

Pin-out	
Pin	Mark
1	-Vin
2	+Vin
4	GND
5	+Vo
8	NC

Note:
Unit:mm[inch]
Pin section tolerances: ±0.10mm[±0.004 inch]
General tolerances: ±0.25mm[±0.010inch]

NC: Pin to be isolated from circuitry

Note: if the definition of pin is not in accordance with the model selection manual, please refer to the label on actual item.

Packing Information

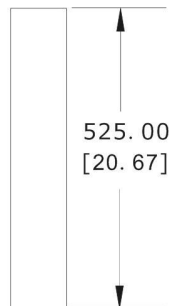
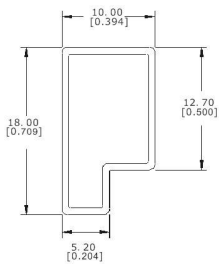

Note:
Unit:mm(inch)
General tolerance:±1.50[±0.059]
Single tube packing qty:39pcs
Carton packing qty:3120pcs
Size of single tube:525x18x10mm
Size of carton:542x110x155mm

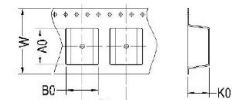
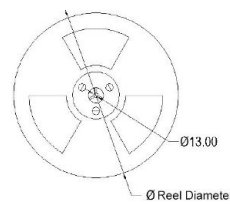

Quadrant assignments for Pin 1 orientation in tape

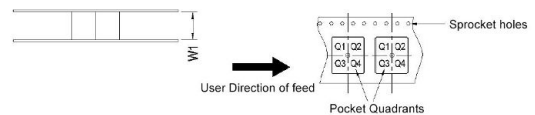

Device	Package Type	PIN	SPO	Reel Diameter (mm)	Reel Width W1(mm)	A0 (mm)	B0 (mm)	K0 (mm)	P1 (mm)	W (mm)	PIN1 Quadrant
NN1-XXSXXANT	SMD	5	500	330	24.5	13.1	11.7	7.5	18.0	24	Q1

Packaging tube packaging method

Taping packaging method (500PCS per roll)



Note:

1. If the product is operated under the min. required load, the product performance cannot be guaranteed to comply with all performance indexes in this datasheet;
2. The maximum capacitive load is tested under nominal input voltage range and full load condition;
3. Unless otherwise specified, data in this datasheet are tested under conditions of **Ta=25°C**, **humidity<75%** when inputting nominal voltage and outputting rated load(pure resistance load);
4. All index testing methods in this datasheet are based on our Company's corporate standards.
5. We can provide customized product service;